

GETTING STARTED? EASY.



ZWS724A5S

ZH 用户手册 洗衣机	2
EN User Manual Washing Machine	24

ZANUSSI

造訪我們的網站可以：



獲得使用建議、手冊、故障解決方案、服務和維修資訊：

www.zanussi.com/support

⚠ 安全資訊

請務必依據提供的指示操作本機，否則會發生安全事件。請在安裝和使用本機之前，仔細閱讀所提供的指示。對於安裝和使用錯誤所造成的人身傷害或損害，製造商概不負責。務必將說明書擺放在安全可觸及的地方，以便將來參考。

青少年和易受傷者的安全

- 未滿 8 歲的青少年不得使用本機。8 歲 (含) 以上之青少年、身體官能或心智能力衰退者，或是經驗與使用知識缺乏者，在負責其安全的人員在旁看護或指示本機的使用方法，並讓他們了解可能之危險的情況下，方可使用本機。
- 除非監護人持續在旁監看，否則青少年、身體官能或心智能力衰退者應遠離本機。
- 請勿讓青少年將本機器成玩具。
- 將洗衣劑放在青少年不易觸及的地方。
- 打開機門時，請讓青少年和寵物遠離這部機器。
- 體格、感官或精神能力不健全，或者是缺少經驗和知識的青少年和人士不得清潔和維護本機。

一般安全需知

- 本機僅供一般家庭使用。
- 請勿變更本機的規格。
- 本機衣物量上限為 7 kg。請勿超過每個程序的衣物量上限 (請參閱「程序」章節)。
- 插座連接處進水點的操作水壓必須介於 0.5 巴 (0.05 兆帕) 和 8 巴 (0.8 兆帕)。
- 底座的通風開口絕對不能被地毯、地墊或任何地板的遮蓋物堵塞。
- 請使用隨附的新軟管組件，或是「授權服務中心」所提供的新軟管組件來連接本機和主水管。
- 嚴禁重覆使用老舊的軟管組件。

- 如果主電源線已損壞，則必須由製造商、其維修代理商或類似的合格人員更換，以避免發生觸電危險。
- 在進行任何保養前，請先停止本機，並從電源插座將電源插頭拔下。
- 請勿使用高壓噴霧和/或蒸氣清潔機器。
- 以濕布清潔本機。僅限使用中性清潔劑。請勿使用研磨性產品、研磨性清潔抹布、溶劑或金屬物體。

安全說明

安裝



安裝必須符合相關國家規範。

- 拆除所有包裝和搬運用螺栓，包含具有塑膠套筒的橡膠刷。
- 將搬運用螺栓存放在安全的場所。將來如果要移動本機，必須將滾筒上鎖以避免內部損傷。
- 移動本機時務必小心，因為器具很重。請務必使用安全手套，並穿上有包覆性的鞋子。
- 請按照本機隨附的安裝指示進行安裝。
- 本機若受損，請勿安裝或使用。
- 請勿在溫度低於 0°C，或在會暴露於風雨的環境中安裝或使用本機。
- 安裝本機的地面必須是平穩、防熱且乾淨的。
- 務必讓本機與地板間可流通空氣。
- 將本機安裝至固定位置後，請利用水平儀檢查其是否保持水平狀態。如果不是，請視情況將機腳予以調整。
- 請勿將本機直接安裝在地板排水系統上。
- 請勿對本機使用噴灑水分，而且不要讓本機暴露在過量濕度中。
- 請勿將本機安裝在機門無法完全打開的位置。
- 請勿將關閉容器置於本機下方以承接可能的漏水。請與「授權服務中心」聯絡，確認哪些是可以使用的配件。

電氣連接



警告! 可能會導致火災和觸電危險。

- 本機必須接地。
- 一律使用已正確安裝的防震插座。
- 確定銘牌上的參數與主電源電功率額定值相容。
- 請勿使用多插頭轉接插座和延長線。
- 請確認本機的電源插頭和電線不會遭到損壞。若需要更換電源線，應該交由我們的授權服務中心執行。
- 只有在安裝結束時才能將電源插頭接上電源插座。請確認於安裝之後，電源插頭位於伸手可及之處。

- 如果雙手潮濕，請勿接觸電源線或電源插座。
- 請勿以拉扯電源線的方式拔掉本機電源線。請一律從電源插頭處拔下。
- 本機配有 13 安培的電源插頭。如果必須更換電源插頭的保險絲，請使用 13 安培 ASTA (BS 1362) 的保險絲。

水源連接

- 切勿損壞水管。
- 將本機連上全新管線、久未使用會進行維修的管線，或裝配新裝置(水表等)之前，請讓水完全流乾與潔淨。
- 確保使用本機期間和初次使用之後沒有明顯的漏水問題。
- 若進水軟管太過短，請勿使用延長管。和授權服務中心聯絡更換進水軟管。
- 拆除本機包裝時，可看見水從排水軟管流出。這是因為已在原廠對本機進行水流測試。
- 排水軟管最多可延長至 400 公分。授權通知服務中心更換其他排水軟管與延長軟管。
- 請確認於安裝之後，水龍頭位於伸手可及之處。

使用方式



警告! 受傷、觸電、失火、燙傷或對本機造成損壞的風險。

- 請遵守洗衣劑包裝的安全說明。
- 請勿將易燃產品或沾染可燃產品的物品放在本機內部、附近或上方。
- 請勿清洗因為油脂或任何其他油膩物質而嚴重髒污的衣物。這可能毀損洗衣機的橡膠零件。先用手預先清洗衣物，然後再將之放入洗衣機。
- 洗衣程序運作時切勿碰觸機門玻璃。玻璃可能極高溫。
- 請確定已取下要洗衣物上的所有金屬物件。

服務中心

- 聯絡「授權服務中心」以修復本機。
- 請只使用原廠備用零件。

廢棄處理



警告! 受傷或窒息的風險。

- 拔除本機的主電源線和水源。

- 剪斷本機附近的主電源線並丟棄。
- 移除機門門門，以防止兒童或寵物被關在滾筒內。
- 丟棄本機時，需依據當地廢棄電氣與電子設備 (WEEE) 的棄置規定。

安裝說明



警告! 請參閱「安全性」一章。

拆除包裝

1. 卸除外部薄膜。如有必要可使用美工刀。

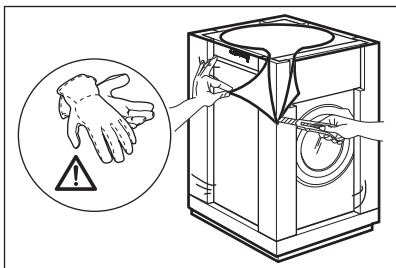

2. 移除紙盒頂端和聚苯乙烯包裝材料。

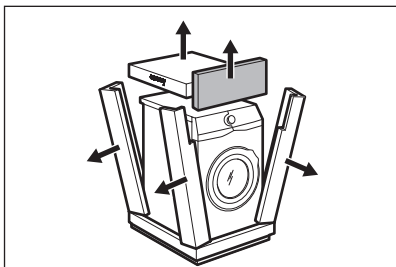

3. 打開機門。將所有衣物自滾筒內取出。

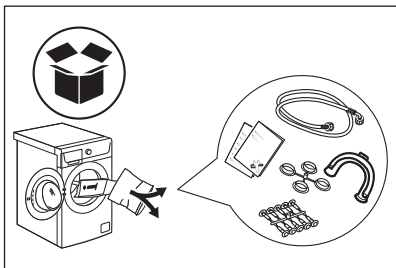

4. 在本機後方放置其中一個聚苯乙烯包裝元件於地板上。小心地將本機的后背放置在地上。

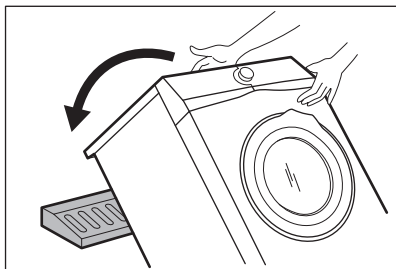

5. 拆除底部聚苯乙烯保護膜。

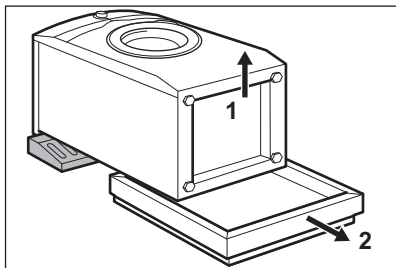

6. 從操作台移除箱體底蓋。使用您在使用者手冊包中的夾子，將蓋子連接到本機底部。

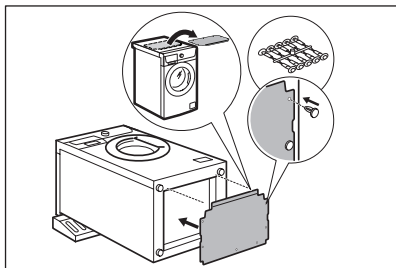

7. 將本機重新放回直立位置。取下電源線和排水軟管。

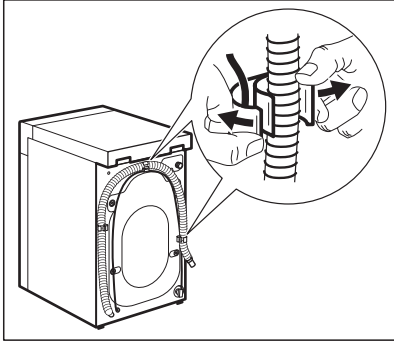

警告! 可看見水從排水軟管流出。這是因為洗衣機已在原廠進行過測試。

8. 拆下四顆運輸用螺栓，然後拉出塑料墊片。

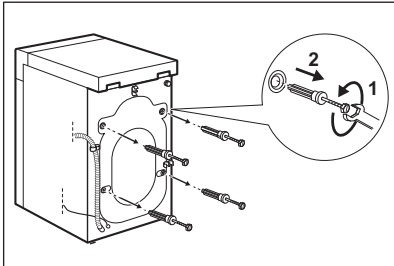

9. 將使用者手冊包中隨附的橡膠蓋放入孔洞中。

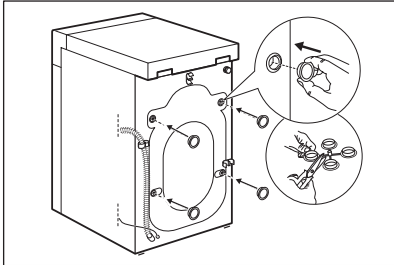

建議您保存包裝及搬運螺絲以便於運輸本機。

安裝資訊

定位與平衡調節

正確調整本機，以防止本機在運行時發生振動、噪音和移動。

1. 在平坦的硬地板上安裝本機。本機必須調平且保持穩定。確保本機不接觸牆壁或其他設備，並且本機下方有空氣循環。

2. 鬆開或鎖緊機腳以調整高度。所有的機腳必須牢牢地靠在地板上。



警告! 請勿將紙盒、木材或同質材料放在本機機腳下方調整高度。

進水軟管



警告 確認軟管沒有任何損傷，接頭處沒有任何洩漏。若進水軟管太過短，請勿使用延長管。請聯絡服務中心更換進水軟管。

1. 將進水軟管連接到此機背面。

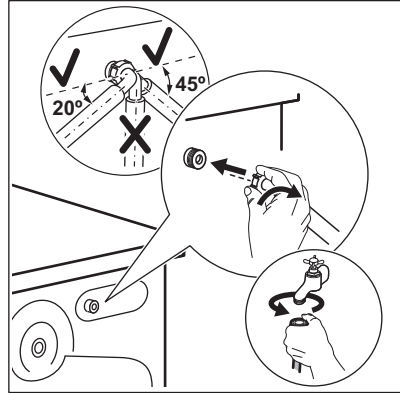

2. 依據水龍頭的位置，將之放在左側或右側。確定進水軟管不是位於垂直位置。

3. 如有需要，鬆開環形螺帽以將其固定在正確位置。

4. 使用 3/4" 吋管線將進水軟管連接至冷水龍頭。

排水

排水軟管高度必須在 60 公分以上、100 公分以下。



排水軟管可以延伸至 400 cm。請聯絡授權服務中心，取得更多排水軟管與延長部分。

可透過不同方法連接排水軟管：

1. 將排水軟管彎成 U 型，然後將之圍繞塑膠軟管導

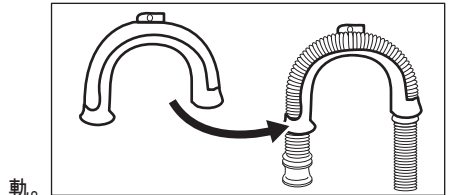

軌。

2. 在水槽邊緣處 - 將導軌固定在水龍頭或牆壁。

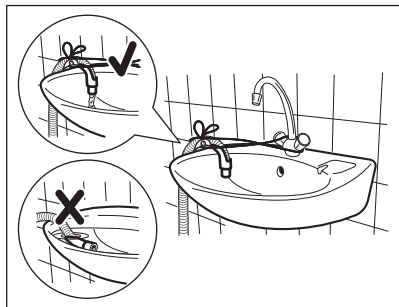

i 當本機排水且排水軟管末端未浸入水中時，確保塑料導軌不能移動。這可能導致髒水回流至本機。

3. 如果排水軟管的末端看起來像這樣（請參閱圖片），您可以直接將此插入儲水塔。

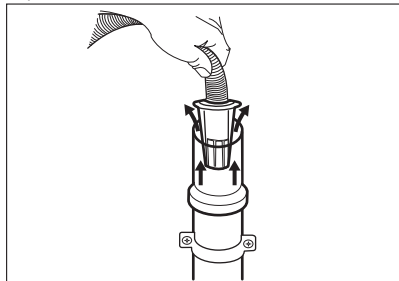

4. 若要將管道固定在通氣孔 - 將排水軟管直接插入排水管道中。請參閱圖例。

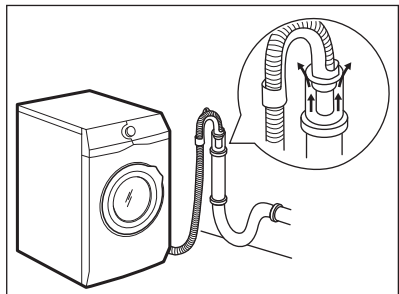

i 排水軟管的末端必須保持通風，即排水管道的內徑（最小 38 公釐 - 最小 1.5 吋）必須大於排水軟管的外徑。

5. 如果沒有橡膠軟管導軌，則連接至排水龍頭 - 將排水軟管放入排水龍頭中，然後用扣夾鎖緊。請參閱圖例。

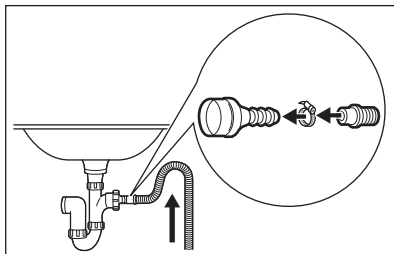

請確定

排水軟管形成環路，以避免塵粒從水槽進入本機。

6. 將軟管直接放入房間牆壁內部的排水軟管，並以扣夾固定。

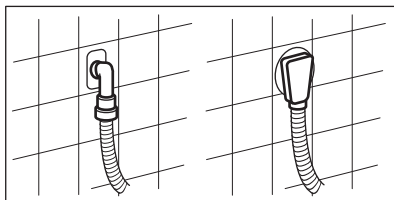

電氣連接

在安裝結束時，您可以將電源插頭連接到電源插座。

銘牌和「技術資料」一章指示必要的電功率額定值。請確定與主電源相容。

請檢查您的家用電氣安裝是否可承受所需的最大負載，並且考慮任何使用中的其他電器。

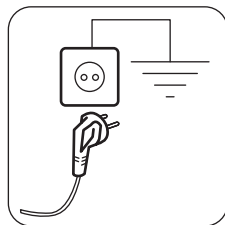

將設備連接到接地插座。

安裝設備後，必須易於接拔電源線。

有關安裝此設備所需的任何電氣工作，請聯絡我們的授權服務中心。

針對不遵守上述安全預防措施而造成的損壞或傷害，製造商概不負責。

產品說明

本機概述

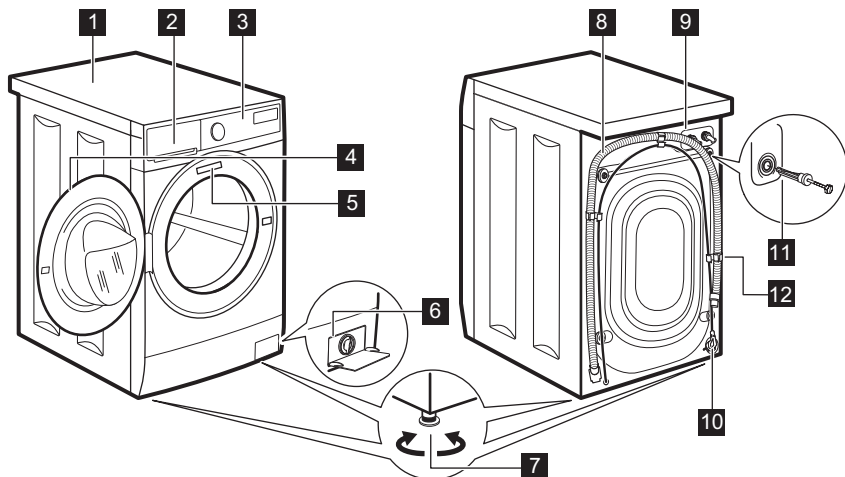

- 1 操作台
- 2 洗衣劑分配器
- 3 控制板
- 4 機門手把
- 5 銘牌
- 6 排水泵過濾器
- 7 調整本機高度的機腳

- 8 排水軟管
- 9 進水軟管連接
- 10 電源纜線
- 11 搬運用螺栓
- 12 軟管支撐

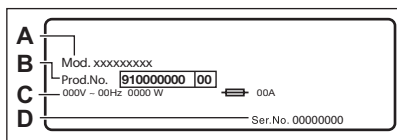

銘牌上顯示機型名稱 (A)、產品編號 (B)、電功率額定值 (C) 和序號 (D)。

控制面板

特殊功能

全新的洗衣機符合低水量、耗電量和洗衣劑使用量，且兼顧布料處理之有效衣物處理的所有現代要求。

AutoAdjust System 會根據滾筒中的衣物量自動調整程序的工作時長，盡可能在最短的時間內達到

最佳的洗衣結果。如需更多詳細資訊，請參閱「AutoAdjust 衣物量偵測」段落。

控制面板說明

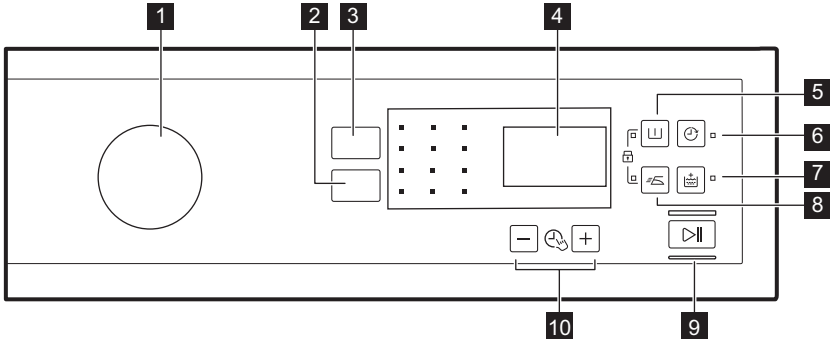



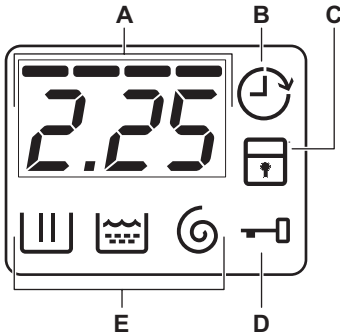

- 1** 設定程序旋鈕
- 2** Spin 減少觸控板
- 3** Temp 觸控板
- 4** 顯示項目
- 5** Prewash  觸控板
- 6** Delay Start  觸控板

- 7** Extra Rinse  觸控板
- 8** Easy Iron  觸控板
- 9** Start/Pause  觸控板
- 10** FlexiTime  +



顯示器



- A.** 時間區域：
 - 程序時間。
 - 警告代碼。請參閱「疑難排解」一章以取得其說明。
 - FlexiTime  的等級。
- B.** 預約啟動指示燈。
- C.** 兒童安全鎖指示燈。
- D.** 門鎖指示燈：
 - 亮起時，您無法打開機門。
 - 熄滅時，您可以打開機門。
 - 閃爍時，您無法打開機門。等待幾分鐘，直到指示燈熄滅為止。
- E.** 清洗階段指示燈。
 - ：清洗階段
 - ：沖洗階段
 - ：脫水階段

程序











程序表

程序 預設溫度 溫度範圍	參考脫水轉速 脫水轉速範圍	最大洗衣量	程序說明 (衣物類型和髒污程度)
棉質 40°C 90°C - 冷洗	1200 rpm (1200- 400 rpm)	7 公斤	白色和有色棉質衣物。一般嚴重或輕微髒污的衣物。
棉質節能 ¹⁾ 40°C 60°C - 40°C	1200 rpm (1200- 400 rpm)	7 公斤	白色和不易褪色的棉質衣物。一般髒污的衣物。耗電量減少，且清洗程序的時間延長，以確保理想的清洗結果。
合成 40°C 60°C - 冷洗	1200 rpm (1200- 400 rpm)	3 公斤	合成纖維或混合布料衣物。一般髒污的衣物。
纖柔 40°C 40°C - 冷洗	1200 rpm (1200-400)rpm	1,5 公斤	質地纖細的衣物，如丙烯酸纖維、黏膠纖維及混合布料需要溫和清洗。一般或輕微髒污的衣物。
 羊毛 40°C 40°C - 冷洗	1200 rpm (1200- 400 rpm)	1,5 公斤 1200 rpm	附有「手洗」處理符號之機洗毛織物、手洗毛織物和其他衣物 ²⁾ 。
 絲 30°C	800 rpm (800- 400 rpm)	3 公斤	適合絲織品及混合合成纖維衣物的特殊程序。
羽絨被 40°C 60°C - 30°C	800 rpm (800- 400 rpm)	2 公斤	適合單件合成纖維毛毯、羽絨、床單等的特殊程序。
過水 冷洗	1200 rpm (1200- 400 rpm)	7 公斤	沖洗衣物和脫水。所有衣物，除了羊毛和非常纖細的衣物。根據衣物種類而降低脫水轉速。
排水 冷洗	免脫水	7 公斤	將滾筒內的水排乾。所有衣物。
脫水 冷洗	1200 rpm (1200- 400) rpm	7 公斤	所有衣物，除了羊毛和纖細衣物。。將衣物放入滾筒內脫水並將水排出。
羊毛 40°C 60°C - 冷洗	1200 rpm (1200- 400) rpm	7 公斤	粗斜牛仔和針織衫。也適用於深色衣物。
窗簾 40°C 40°C - 冷洗	800 rpm (800- 400 rpm)	1 公斤	窗簾專用的特殊程序。預洗階段會自動啟動。 ³⁾



程序 預設溫度 溫度範圍	參考脫水轉速 脫水轉速範圍	最大洗衣量	程序說明 (衣物類型和髒污程度)
清新洗 30°C	800 rpm (800- 400 rpm)	2 公斤	合成和質地纖細的衣物。輕微髒污的衣物或欲清新的衣物。
 快洗 30°C	800 rpm (800- 400 rpm)	1 公斤	合成纖維和混合布料衣物。輕度髒污衣物與欲清新的衣物。

- 1) 此 60 °C 且衣物量為 7 kg 的程序，是能源標籤資料的參考程序，並符合 IEC 60456。
- 2) 此程序期間，滾筒會緩慢旋轉，以確保能輕柔地洗滌。這可能看起來像是滾筒並未旋轉或未適當旋轉，但這對此程序而言是正常的。
- 3) 請勿將任何洗衣劑用在預洗階段，只以清水過水。

程序選項相容性

程序				 預洗	 預約	 易燙洗	 額外過水	FlexiTime
棉質	■	■	■	■	■	■	■	■
棉質節能	■	■	■	■	■	■	■	■
合成	■	■	■	■	■	■	■	■
纖柔	■	■	■	■	■	■	■	■
  羊毛	■	■	■		■			
 絲	■	■			■			
羽絨被	■				■			
過水	■	■	■		■		■	
排水					■			
脫水	■				■			
羊毛	■	■	■	■	■	■	■	■
窗簾	■	■	■		■	■	■	■
清新洗	■	■			■			
快洗 	■	■			■			

各洗衣程序適用的洗衣劑

程序	一般粉狀洗衣劑 ¹⁾	普通液體洗衣液	紅色衣物液體洗衣液	纖細羊毛衣物	特殊
棉質	▲	▲	▲	--	--
棉質節能	▲	▲	▲	--	--
合成	▲	▲	▲	--	--
纖柔	--	--	--	▲	▲
 羊毛	--	--	--	▲	▲
 絲	--	--	--	▲	▲
羽絨被	--	--	--	▲	▲
羊毛	--	--	▲	▲	▲
窗簾	--	--	--	▲	▲
清新洗	--	▲	▲	--	▲
快洗 	--	▲	▲	--	--

1) 在溫度高於 60 °C 時建議使用洗衣粉。

▲ = 建議

-- = 不建議

特別功能

溫度

設定此選項，您可以改變預設的溫度。

指示燈  = 冷水。

將會出現設置溫度指示燈。

轉速

藉由此特別功能，您可以改變預設的脫水轉速。

設定之轉速的指示燈會亮起。

其他脫水特別功能：

免脫水

- 設定此特別功能可停用所有脫水階段。僅能執行排水階段。
- 相關指示燈會亮起。
- 為纖細衣物設定此特別功能。
- 過水階段的某些洗衣程序使用較多的水量。

延遲過水

- 設定此特別功能可防止衣物皺摺。
- 相關指示燈會亮起。
- 當程序完成時，滾筒內有水。
- 滾筒會定時轉動以防止衣物皺摺。

- 機門仍舊鎖著。您必須將水排乾，才能解鎖機門。



若要排出清水，請參閱「在程序結束時」章節。

預洗

藉由此特別功能，您可以將預洗階段加入洗衣程序中。

請將此特別功能用於嚴重髒污的衣物。

當您設定此特別功能時，程序持續時間會延長。

相關指示燈會亮起。

預約

藉由此功能，您可將洗衣程序延後 30 分鐘至 20 小時後開始。

顯示器會顯示相關指示燈。

額外過水

藉由此特別功能，您可以將某些過水階段加入洗衣程序中。

對洗衣劑敏感的人士或在水質極軟的地區可使用此特別功能。
相關指示燈會亮起。

易燙洗

本機會仔細清洗衣物並進行脫水，以防止衣物皺摺。
本機會減少脫水轉速，用更多的水，依照衣物類型調整程序持續時間。
相關指示燈會亮起。

FLEXITIME

使用此選項，您可以根據洗衣量大小和髒污程度縮短程序工作時長。此項調整應該在設置 Temp 和 Spin 之後進行。

在您設置了清洗程序時，顯示器會顯示預設工作時長與 ---- 橫線。

觸碰 FlexiTime 按鈕，依據您的需求來縮短程序的工作時長。顯示器將顯示新程序的工作時長，並且相應地減少大量的橫線：



---- 適合裝滿髒污程度一般的衣物。

---- 快速程序，適合裝滿髒污程度一般的衣物。



設定

兒童安全鎖

藉由此特別功能，您可以防止兒童將控制面板當成玩具。

• 若要啟用/停用此特別功能，可同時按下  和  直到  指示燈亮起/熄滅。

您可以啟用此特別功能：

- 在按下  之後：特別功能和程序旋鈕會被鎖住。
- 在按下  之前：本機無法啟動。

永久額外過水

藉由此選項，您可以在設定新程序時，永遠執行額外沖洗。

第一次使用前



在安裝期間或首次使用之前，您可能發現本機中有一些水。這是在工廠中執行完整功能測試之後，本機中殘留的水份，如此可確保本機是以完美運作狀態提供給客戶，而且沒有使用方面的疑慮。



1. 將電源插頭連接到電源插座。

-- 極快程序，適用於較少的輕微髒污衣物（建議最多放入一半的衣物量）。

- 是最短的程序，適合使少量衣物恢復清新。僅能在表內的程序中使用「FlexiTime」。

指示燈	縮短時間	棉質	合成	織物	羊毛	窗簾
-		■	■	■	■	■
--	■	■	■	■	■	■
---		■	■	■	■	■
----1)	■	■	■	■	■	■



1) 所有程序的預設工作時長。

- 若要啟用/停用此選項，可同時按下  和  直到指示燈  亮起/熄滅。

聲音訊號

當發生下列情況時，聲音訊號會運作：

- 程序完成。
- 本機故障。

若要啟用/停用聲音訊號，可同時按下  和  達 6 秒鐘。



如果您停用聲音訊號，當本機故障時，它們仍會繼續運作。

2. 請打開水龍頭。
3. 將 2 公升的水放入洗衣階段的洗衣劑盛載格。此動作會啟動排水系統。
4. 將少量的洗衣劑放入洗衣階段的盛載格。
5. 設定一個無衣物且在最高溫度清洗棉質衣物的程序，並開始運作。

這會清除滾筒和洗衣筒內所有可能的污垢。

日常使用



警告! 請參閱「安全性」一章。

放入衣物

1. 打開本機門蓋。
 2. 掏空所有口袋並且攤開衣物，然後將其放入本機。
 3. 將衣物逐件放入滾筒。
- 不要在滾筒中放太多衣物。
4. 將機門關緊。

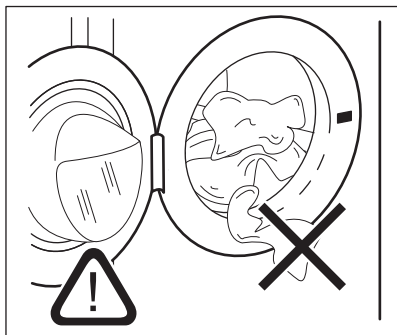

警告 確保密封件和門之間沒有衣物夾住，以避免漏水和損壞衣物的風險。



清洗嚴重油膩污漬可能毀損洗衣機的橡膠零件。

使用洗衣劑和添加劑

1. 量取洗衣劑和衣物調理劑。
2. 將洗衣劑與衣物調理劑倒入盛載格裡。
3. 小心關上洗衣劑抽屜盒

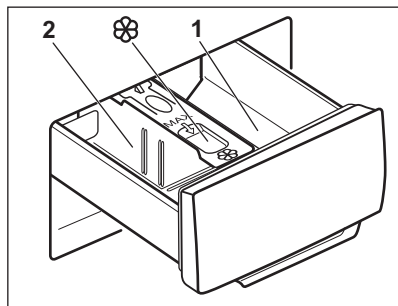

警告 僅使用適合洗衣機的指定洗衣劑。



請務必遵守洗衣劑產品包裝上所列之說明。

1	適用預洗階段的洗衣劑盛載格或浸泡程序 (如果有)。請在程序開始之前，添加預洗和浸泡乳液。
2	適用洗衣階段的洗衣劑盛載格。如果您使用洗衣液，請在開始程序之前先將其放入。
	液體添加劑 (衣物調理劑、衣漿) 的盛載格。請在程序開始前，將洗衣劑放入盛載格中。

洗滌程序之後，移除洗衣劑分配器的任何洗衣劑殘留物 (如有需要)。

變更清潔劑隔板的位置

1. 拉出清潔劑分配器。清潔劑隔板的位置 **A** 適用於粉狀清潔劑 (原廠設定)。

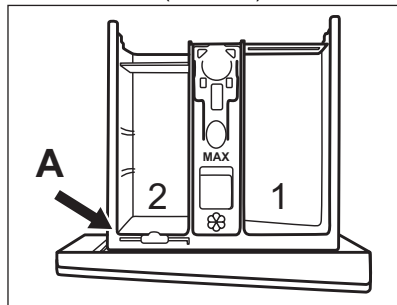

2. 若要使用洗衣液/添加劑或漂白水：從位置 **A** 移除清潔劑隔板，然後將之插入位置 **B**。

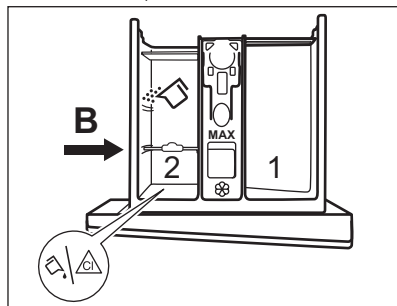

後方隔間之清潔劑隔板的位置 **B**，洗衣液/添加劑或漂白水的位則位於前方隔間。

3. 如欲只使用洗衣液：在位置 **C** 中插入清潔劑隔板。

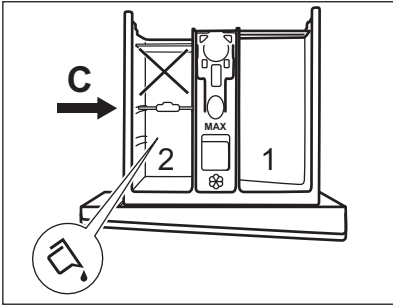

- 請勿使用凝膠狀或粘稠液體洗衣劑。
- 請勿超過液體清潔劑的劑量上限。
- 不可設定預洗階段。
- 不可設定延遲開始功能。

4. 量取洗衣劑和衣物調理劑並仔細關上清潔劑分配器。

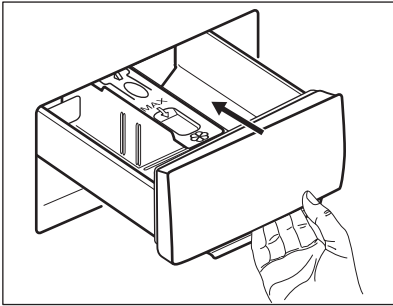

關閉盛載格時，確定已適當插入清潔劑隔板且板子不會堵塞。

設定程序

1. 轉動程序旋鈕並設定程序：

- 指示燈 閃爍。
- 顯示器顯示「時間管理器」的水位、程序持續時間、程序各階段的指示燈。

2. 必要時，改變溫度和脫水轉速，或加入可用的選項。當您啟用選項時，設定選項的指示燈會亮起。

i 如果您設定不正確，顯示器會顯示訊息 **Err.**

開始程序，而不設定延遲開始。

按下 .

- 指示燈會停止閃爍，並一直亮著。
- 指示燈會在顯示器上開始閃爍。
- 程序開始、機門上鎖、顯示器會顯示 指示燈。
- 當洗衣機進水時，排水泵可以短時間運作。

- i** 程序啟動過大約 15 分鐘後：
- 本機會自動調整配合衣物量的程序持續時間。
 - 顯示器會顯示新的數值。

開始程序，並且設定延遲開始

1. 不斷按下 ，直到顯示器顯示您想要設定的延遲時間為止。

相關指示燈會在顯示器上亮起。

2. 按下 ：
- 本機開始倒數計時。
 - 機門鎖緊，則顯示器會顯示指示燈 。
 - 倒數完成時，該程序就會自動開始。

i 您可以在按下 前，取消或改變延遲開始的設定。取消延遲開始：

- 按下 以設定本機暫停。
- 按下 直到顯示器顯示 。
- 再次按下 以立即開始程序。

AUTOADJUST SYSTEM 衣物量偵測

觸碰 Start/Pause 按鈕之後：

1. AutoAdjust System 會開始預估衣物量的重量，以計算真正的程序工作時長。在此階段，顯示器會顯示簡單的動畫。
2. 經過大約 10-15 分鐘之後，會顯示新週期持續時間。
本機會根據衣物量自動調整程序的工作時長，盡可能在最短的時間內達到最佳的洗衣結果。

i 並非所有程序都具備 AutoAdjust System，例如：Wool、Rinse、SpinDrain 及短週期程序。

中斷程序並且改變特別功能

您只能在某些特別功能運作之前對其加以更改。

1. 按下 。
指示燈閃爍。
2. 改變特別功能。
3. 再次按下 。
程序繼續進行。

取消執行程序

1. 請轉動程序旋鈕至位置 ，以取消程序並停用本機。
2. 請再轉動程序旋鈕一次以啟動本機。現在，您可以設定新的洗衣程序。



在開始新的程序前，本機會排水。在此情況下，若未再次注入洗衣劑，請確定洗衣劑仍在洗衣劑盛載格中。

在預約啟動運作或程序開始要運作時開啟機門

在預約啟動運作時或程序剛開始要運作時，機門會鎖定且指示燈  亮起。

1. 按  以暫停本機。

指示燈  開始閃爍。

2. 請等待 2 分鐘直到機門鎖指示燈  開始閃爍並熄滅。

3. 您可以打開機門。

4. 關上機門並再次按下 。

預約啟動或程序會繼續進行。



當您在程序已啟動時暫停本機，但是指示燈  沒有閃爍且機門無法開啟，請關閉本機以開啟機門。請參閱「在程序運作時開啟機門」。

當程序運作時，打開上蓋

程序運作時，機門會鎖定且指示燈  亮起。



警告 如果滾筒的溫度和水位過高，您將無法打開機門。

1. 轉動程序旋鈕至  位置以停用本機。

2. 請等待幾分鐘，然後打開機門。

3. 關閉機門。

4. 再次設定程序。





在程序結束時

- 本機會自動停止。
- 聲音訊號開始運作 (如果已經啟用)。



提示與訣竅

洗衣衣物

- 將衣物分為：白色、有色、合成纖維、纖細和羊毛。
- 請遵守衣物護理標籤上的洗衣說明。
- 請勿將白色及有色衣服放在一起洗。
- 第一次洗滌時，一些有色衣物會褪色。建議您在前幾次單獨清洗。
- 將多層織物、毛織品以及印製圖案的衣物由內向外翻。
- 使用適當的清潔劑來清洗和預先處理嚴重髒污，然後再將之放入滾筒中。
- 請小心清洗窗簾。拆下鉤子，將窗簾放在洗衣袋或枕套中。

- 顯示器上， 會亮起。
 -  的指示燈會熄滅。
 - 機門鎖指示燈  會閃爍幾分鐘，然後熄滅。
 - 您可以打開機門。
 - 將衣物自本機取出。請確定滾筒裡是空的。
 - 關閉水龍頭。
 - 轉動程序旋鈕至 On/Off 位置以停用本機。
 - 保持機門半開狀態，防止發霉和發出臭味。
- 洗衣程序完成，但滾筒內有水：
- 滾筒會定時轉動以防止衣物皺摺。
 - 機門鎖指示燈  亮起。 指示燈閃爍。機門仍舊鎖著。
 - 您必須將水排乾，才能打開機門。

若要排出清水：

1. 按下 。本機會排水並脫水。
2. 當程序完成時，機門鎖指示燈  會閃爍幾分鐘。熄滅時，您可以打開機門。
3. 轉動程序旋鈕至 On/Off 位置以停用本機。



大約經過 18 小時後，本機會自動排水和脫水 (除了毛織品洗衣程序以外)。

待機

洗衣程序結束約 5 分鐘後，如果您不停用本機，會啟動節能狀態。

如果在設定期間約 5 分鐘內沒有進行任何操作，也會啟動節能狀態。

當本機處於待機狀態時，節能狀態會減少耗電量。

- 所有指示燈會熄滅。
-  的指示燈緩慢閃爍。
- 按下其中一個選項以停用節能狀態。



如果您設定的程序或特別功能會於結束時使滾筒內殘留清水，則節能狀態功能未啟用以提醒您排水。

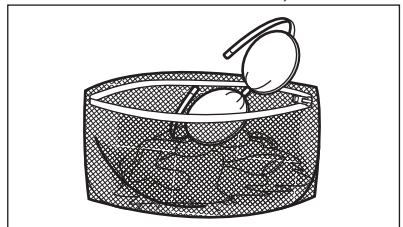

- 切勿清洗沒有縫邊或切邊的衣物。請使用洗衣袋清洗小件和/或纖細衣物 (例如帶有鋼圈的胸罩、腰帶、褲襠、鞋帶、緞帶等)。

- 洗衣量過少會在脫水階段造成失衡的問題，而產生強烈震動。如果發生此情況：
 - 中斷程序並打開機門（請參閱「日常使用」一章）；
 - 手動重新分配衣物量，讓衣物均勻分散在滾筒中；
 - 按下 Start/Pause 按鈕。脫水階段便會繼續。
- 扣好枕套、拉上拉鍊，並扣好鉤扣。繫好腰帶、繩線、鞋帶、緞帶和任何其他鬆脫的元件。
- 清空所有口袋並且攤開衣物。

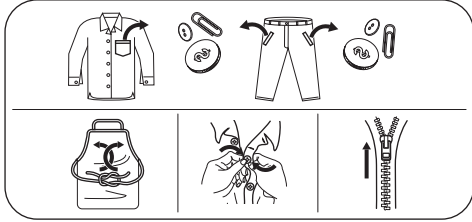

頑固污漬

有些污漬只使用水和清潔劑是不夠的。我們建議您先處理這些污漬，再將其放入本機中。可使用的特殊去漬產品 使用該類型的污漬及布料適用的特殊去漬產品。

洗潔劑類型和用量。

洗潔劑的選擇和正確用量不僅會影響您的洗衣效果，還有助於避免浪費和保護環境：

- 僅使用洗衣機專用的洗潔劑和其他處理劑。首先，請按照這些通用規則：
 - 適用於各類衣物的洗衣粉（纖幼衣物除外）。偏好包含白色衣物的漂白劑和洗衣消毒劑的粉狀洗潔劑。
 - 適用於各類衣物或僅用於羊毛的洗衣液，低溫洗衣程序（最高 60 °C）最好採用洗衣液。
- 洗潔劑的選擇和用量取決於：織物的類型（纖細衣物、羊毛、棉質等）、衣服的颜色、洗衣量、髒污程度、洗衣溫度和洗衣水的硬度。
- 請遵守洗衣劑產品或其他處理劑包裝上的說明，而不要超過指定的濃度上限（MAX）。
- 不要混合不同類型的洗潔劑。

保養與清潔



警告! 請參閱「安全性」一章。

定期清潔排程

定期清潔有助於延長設備的使用壽命。

在每次程序結束後，保持機門和洗衣劑分配器稍微半開狀態，使空氣流通並讓設備內部的濕氣消散。這能防止發霉和異味。

- 如有以下情況，請使用更少的洗潔劑：
 - 清洗少量衣物、
 - 衣物的髒污輕微、
 - 清洗時有大量泡沫。
- 使用洗衣錠或洗衣球時，務必將其放入滾筒內，而不是放入洗潔劑分配器中。

洗潔劑不足可能會導致：

- 洗衣效果不滿意、
- 洗滌量變成灰色、
- 衣物油膩、
- 設備中形成黴菌。

洗潔劑過多可能會導致：

- 起泡、
- 降低洗衣效果、
- 沖洗不足、
- 對環境的影響更大。

環保指示

為省水、節能並保護環境，我們建議您遵照下列幾個指示：

- 髒污程度一般的衣物可以不必預洗，以節省洗潔劑、水和時間（同時也能保護環境！）。
- 將本機裝到每個程序指示的最大容量，能幫助協省能源和水。
- 藉由充分的事前處理可以去除污漬和部分污垢；衣物將可於較低的溫度清洗。
- 請參閱洗潔劑製造商的使用量建議，並確認家用自來水系統的水硬度，以使用正確的洗潔劑用量。請參閱「水質硬度」。
- 為所選的洗衣程序設定最大脫水轉速後，再將衣物放入滾筒乾衣機烘乾。這樣一來就能在烘乾時節省能源！

水質硬度

如果您的水質硬度很高或適中，我們建議您使用洗衣機專用的軟水劑。對於水質極軟的地區，沒有必要使用軟水劑。

若要知道您當地的水質硬度，請聯絡當地負責自來水的機關。

請使用正確的軟水劑用量。請遵守這些產品包裝上的說明。

如果長時間不使用設備，請關閉水龍頭並拔下電源插頭。

建議定期清潔排程：

除垢	一年兩次
保養洗滌	每月一次
清潔門封	每兩個月

清潔滾筒	每兩個月
清潔洗衣劑分配器	每兩個月
清潔排水泵濾網	一年兩次
清潔進水軟管和閥的濾網	一年兩次

以下各段說明如何清潔每個零件。

清除異物

- i** 在進行程序之前，請確保掏空口袋且所有鬆散的部分皆已綁好。請參閱「提示與訣竅」中的「衣物量」。

清除任何可能在門封、濾網和滾筒中找到的異物(例如金屬夾、鈕扣、硬幣等)。請參閱「帶雙唇夾的門封」、「清潔滾筒」、「清潔排水泵」和「清潔進水軟管和閥的濾網」段落。如有需要，請聯絡「授權服務中心」。

外部清潔

僅以溫合的肥皂和溫水清潔本機。使整個表面完全乾燥。請勿使用菜瓜布或任何會刮傷機器的材料。

- !** 警告 請勿使用甲基性酒精、溶劑或化學產品。

- !** 警告 請勿使用含氯的洗衣劑來清潔金屬表面。

除垢

如果您的水質硬度很高或適中，我們建議您使用洗衣機專用的除水垢產品。

定期查看滾筒以防止水垢及微粒。

僅以洗衣機專用的產品去除塵粒。請和洗衣程序分開處理。

- i** 請務必遵守您在這些產品包裝上找到的說明。

保養洗滌

若使用低溫程序，某些洗衣劑可能殘留在滾筒內。定期執行保養洗滌。請按照以下步驟執行：

- 將所有衣物自滾筒內取出。
- 選取棉質程序高溫清洗，並使用少量洗衣劑。

帶雙唇夾的門封

本機設計有自清潔排水系統，允許從衣服上脫落的輕絨毛纖維與水一起排出。定期檢查密封圈。在程序結束時，可能會留下硬幣、鈕扣和其他小物品。

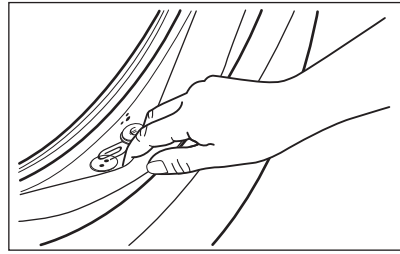

必要時進行清潔，使用氨霜清潔劑，以免刮傷密封圈表面。

- i** 請務必遵守產品包裝上的說明。

檢查並移除可能會夾在折疊衣物中的物品(若有任何物品)。

確認密封圈和機門之間沒有衣物。

在程序週期完成之後，使用濕布擦除任何殘存在機門門封之後的污垢或水漬。

清潔滾筒

定期查看滾筒以防止產生微粒。

利用特殊不鏽鋼產品清潔滾筒。

- i** 請務必遵守產品包裝上的說明。

如需徹底洗滌：

- 將所有衣物自滾筒內取出。
- 以最高溫度執行 Cottons 程序。將少量粉狀洗衣劑加入空的滾筒中，以便脫水掉任何餘留下來的殘留物。

清潔洗衣劑分配器

若要乾掉的洗衣劑沉澱或阻塞的棉質衣物軟化劑及/或洗衣劑分配器中形成黴菌，請偶爾執行下列清潔程序：

1. 打開抽屜盒。依照圖片所示，向下按下把手，然後向外拉出。

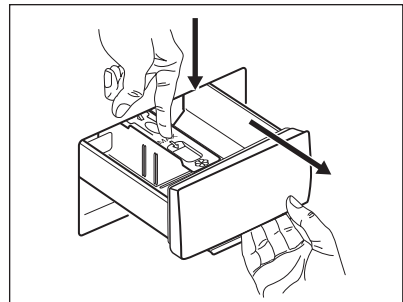

2. 移除添加劑盛載格的頂端部分，以協助在注入持續流動的溫水時，清潔和沖出添加劑，以移除累積洗衣劑的任何殘留物。清潔之後，將頂端部分放回原位。

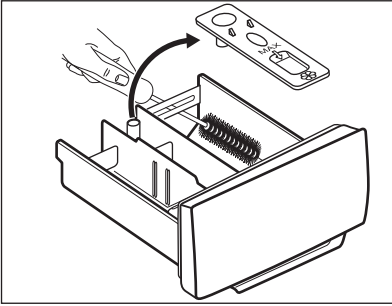

3. 確定已經從凹槽的上方和下方移除所有洗衣劑殘留物。使用小刷子清潔凹槽。

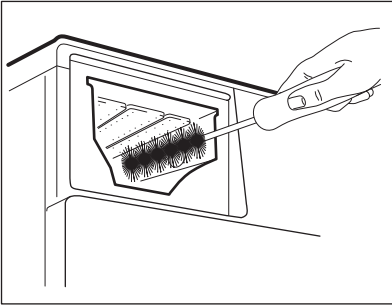

4. 將洗衣劑盛載格插入滑軌並予以關閉。執行脫水程序，而不要在滾筒內放入任何衣物。

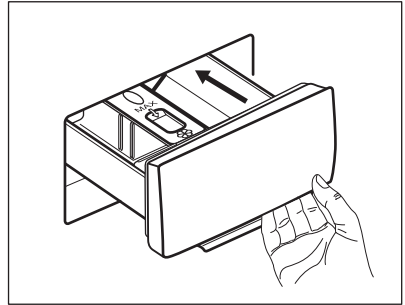

清潔排水泵

定期檢查排水泵濾網並確保清潔。

在下列情況下，清潔排水泵：

- 本機未排水。
- 洗衣鼓並未轉動。
- 因為排水泵堵塞，洗衣機發出異常的噪音。
- 顯示器顯示警示代碼 **E20**



警告!

- 將電源插頭從電源插座拔出。
- 本機運作時，切勿卸下濾網。
- 如果本機內為熱水，請勿清潔排水泵。等待直到水變冷為止
- 關閉和打開閥，直到水停止流出為止，重複步驟 3 數次。

卸下濾網時身邊應準備一塊布隨時抹乾任何流出來的水。

按照下列指示以清潔排水泵：

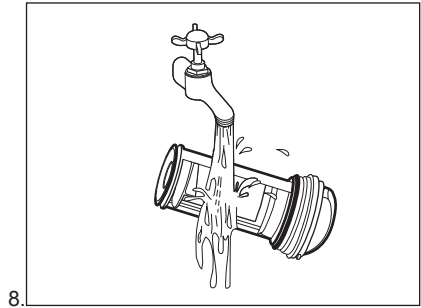
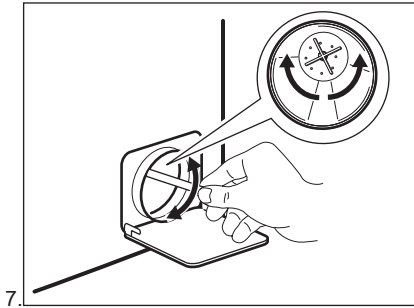
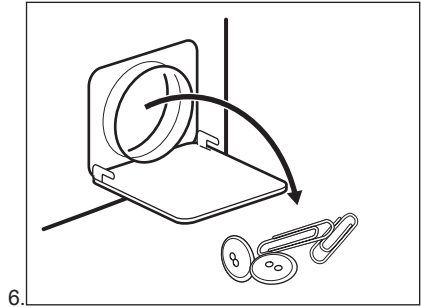
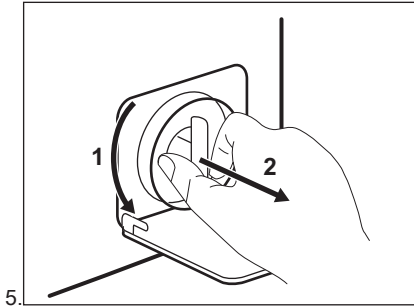
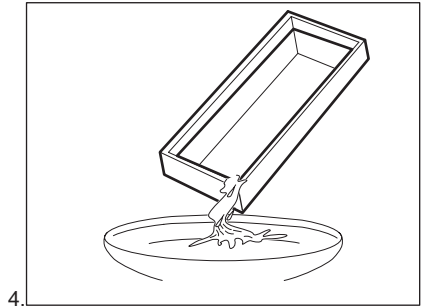
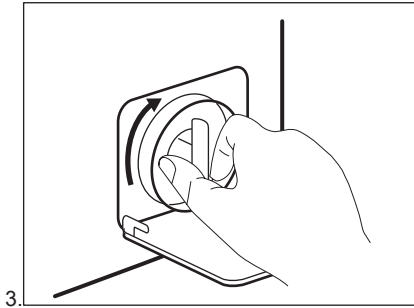
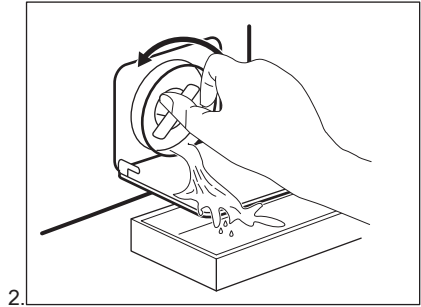
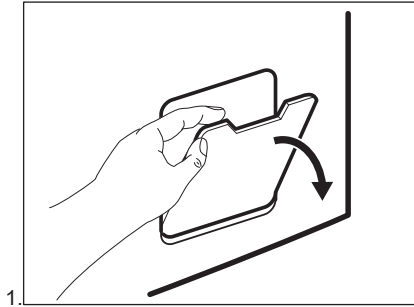

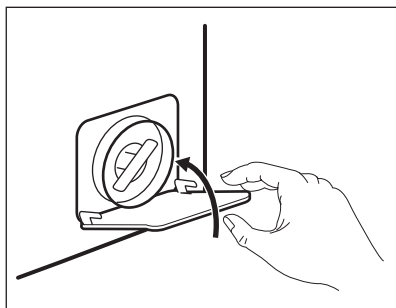
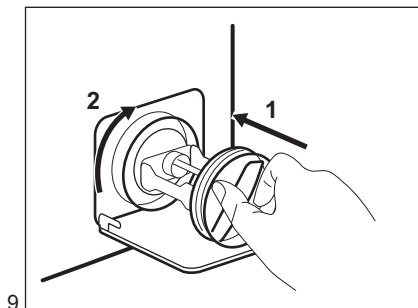

警告! 請確認泵的葉輪能旋轉。如果並未旋轉，請聯絡授權服務中心。也確認已將濾網正確旋緊，防止洩漏。

依照緊急排水程序排水時，必須再次啟動排水系統：

1. 將 2 公升的水倒入洗衣劑分配器的主洗盛載格。
2. 開啟程序將水排出。

清潔進水軟管和閥過濾器

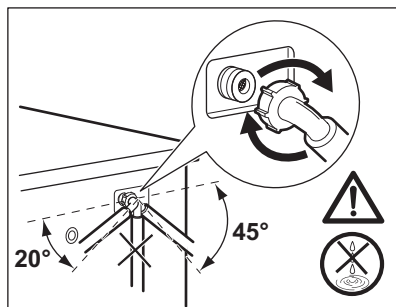
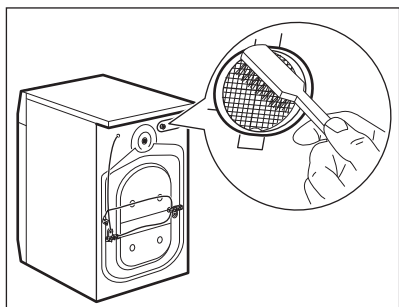
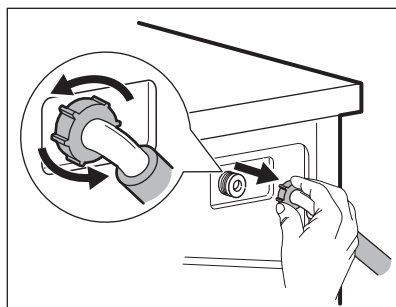
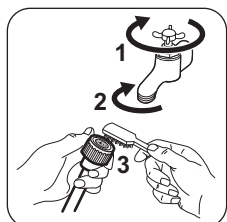

緊急排水

因為故障，本機無法排水。

如果發生此情況，請執行「清潔排水過濾器」中 (1) 至 (10) 的步驟。必要時，清潔排水泵。

依照緊急排水程序排水時，必須再次啟動排水系統：

1. 依照緊急排水程序排水時，必須再次啟動排水系統：將 2 公升的水倒入洗衣劑分配器的主洗盛載格。
2. 開啟程序將水排出

預防霜凍

如果將本機安裝在溫度可能低於 0°C 的位置，請從進水軟管和排水泵排出剩餘的水。

1. 將電源插頭從電源插座拔除。
2. 關閉水龍頭。
3. 將進水軟管兩端放在容器內，並讓水排出軟管。
4. 清空排水泵。請參閱緊急排水程序。
5. 當排水泵清空時，再一次安裝進水軟管。



警告! 當您再次使用本機時，請確定溫度大於 0 °C。
對於低溫造成的損害，製造商概不負責。

疑難排解



警告! 請參閱「安全性」一章。

警示代碼和可能的故障情形

本機在運轉時無法啟動或停止。請先試著找到問題的解決辦法(請參閱表格)。



警告! 請先停止本機再進行任何檢查。

某些問題會在顯示器上顯示警示代碼，且 Start/Pause 按鈕會持續閃爍：

問題	可能的解決辦法
E 10 本機未適當注水。	<ul style="list-style-type: none"> • 請確定水龍頭已經開啟。 • 請確定供水壓力並未過低。如需瞭解此資訊，請聯絡您當地的自來水機關。 • 請確定水龍頭沒有阻塞。 • 請確定進水軟管未扭結、破損或彎曲。 • 請確定已正確連接進水軟管。 • 請確定進水軟管過濾器和閥過濾器沒有阻塞。請參閱「保養與清潔」章節。
E20 設備沒有排水。	<ul style="list-style-type: none"> • 請確定排水龍頭未阻塞。 • 請確定排水軟管未扭結或彎曲。 • 請確定排水過濾器未阻塞。如有需要，請清潔過濾器。請參閱「保養與清潔」章節。 • 請確定已正確連接排水軟管。 • 如果設定無排水階段的程序，請設定排水程序。 • 如果您設定的選項會在結束時使洗衣筒內殘留清水，請設定排水程序。
E40 機門已開啟或未關妥。	<ul style="list-style-type: none"> • 請確定機門已關妥。
E91 內部故障。本機的電子元件之間無通訊。	<ul style="list-style-type: none"> • 程序並未適當完成，或是過早停止本機。再次關閉並開啟設備。 • 如果警示代碼再次出現，請聯絡「授權服務中心」。
Eh0 主電源不穩定。	<ul style="list-style-type: none"> • 請等待直到主電源穩定。

如果顯示器顯示其他警示代碼，則停用並啟用本機。如果問題持續存在，請聯絡「授權服務中心」。

如果洗衣機有其他問題，請檢查下表以尋找可能的解決辦法。

問題	可能的解決辦法
程序未開始。	<ul style="list-style-type: none"> • 請確定電源插頭已經連接至電源插座。 • 請確定機門已關閉。 • 請確定保險盒中的保險絲沒有損壞。 • 請確定 Start/Pause 已觸碰。 • 如果設定了預約啟動，請取消設定或等待倒數計時結束。 • 如果「兒童安全鎖」功能啟動，請停用。 • 檢查所選程序的旋鈕位置。
本機立即注水並排水。	<ul style="list-style-type: none"> • 請確定排水軟管在正確的位置上。軟管位置可能太低。請參閱「安裝說明」章節。
脫水階段未運作或洗衣程序的時間比一般更久。	<ul style="list-style-type: none"> • 設定脫水程序。 • 請確定排水過濾器未阻塞。如有需要，請清潔過濾器。請參閱「保養與清潔」章節。 • 手動調節洗衣筒中的衣物，然後重新開始脫水階段。這個問題可能起因於失衡。
地板上有水。	<ul style="list-style-type: none"> • 請確定水管接頭處緊固且沒有漏水。 • 請確定進水軟管和排水軟管未損壞。 • 請確定使用正確的洗衣劑和正確的用量。
您不可以打開本機上蓋。	<ul style="list-style-type: none"> • 請確定並未選取最後會將水注入洗衣筒的洗衣程序。 • 請確定洗衣程序已完成。 • 如果滾筒內有水，請設定排水或脫水程序。
本機發出異常的噪音和震動。	<ul style="list-style-type: none"> • 請確定設備平衡放置。請參閱「安裝說明」章節。 • 請確定已移除包裝和/或運輸用螺栓。請參閱「安裝說明」章節。 • 請在滾筒中放入更多衣物。衣物量可能過少。
程序持續期間在程序執行期間增加或減少。	<ul style="list-style-type: none"> • 透過 AutoAdjust System 可依據類型和洗衣量大小而調整程序持續時間。請參閱「日常使用」一章的「AutoAdjust System 衣物量偵測」。
清洗效果不理想。	<ul style="list-style-type: none"> • 請增加洗衣劑用量或使用其他洗衣劑。 • 在洗滌衣物之前，請先使用特殊產品去除頑強污漬。 • 請確定您設定正確的溫度。 • 減少洗衣量。
洗衣程序期間滾筒內產生太多泡沫。	<ul style="list-style-type: none"> • 減少洗衣劑的用量。
洗滌程序之後，分配器中有一些洗衣劑殘留物。	<ul style="list-style-type: none"> • 確定翻蓋位於正確位置（「上」適用於粉狀洗衣劑 - 「下」適用於液體洗衣劑）。 • 請確定您已經依據此使用者手冊提供的指示來使用洗衣劑分配器。

檢查後，啟動本機。程序會從中斷處繼續運轉。
如果問題再次出現，請聯絡「授權服務中心」。
服務中心的必要資料位於銘牌上。

服務

建議您使用原廠零配件。



與「授權服務中心」聯絡時，請確保您已備妥這些資料。您可在銘牌上找到以下資訊：型號、PNC 與序號。(Mod., Prod. No., Ser. No.)

技術資料

尺寸	寬/高/總深度	595 mm / 843 mm / 488 mm
電氣連接	電壓 總功率 保險絲 頻率	220 V 2000 W 13 A 50 Hz
防護罩確保防止固體顆粒和水分進入的防護等級，無防潮功能的低電壓設備除外		IPX4
供水壓力	下限 上限	0.5 bar (0.05 MPa) 8 bar (0.8MPa)
供水 ¹⁾		冷水
最大洗衣量	棉質衣物	7 公斤
脫水轉速	最大脫水轉速	1200 rpm

1) 使用 3/4" 吋管線將進水軟管連接至水龍頭。

環境關懷

回收有標誌  的材料。請將包裝材料放到適當的容器中予以回收。回收電子和電氣器具廢棄物有利於保護環境及人類健康。請勿將有標誌  的器

具與家用廢棄物一同處理。請將產品送至當地回收廠或聯絡市政府辦公室。

VISIT OUR WEBSITE TO:



Get usage advice, brochures, trouble shooter, service and repair information:
www.zanussi.com/support

SAFETY INFORMATION

Please be sure to operate the appliance in accordance with the supplied instructions otherwise safety incidents may occur. Before the installation and use of the appliance, carefully read the supplied instructions. The manufacturer is not responsible for any injuries or damage that are the result of incorrect installation or usage. Always keep the instructions in a safe and accessible location for future reference.

JUVENILES AND VULNERABLE PEOPLE SAFETY

- The juveniles aged under 8 years shall not use this appliance. This appliance can be used by juveniles aged from 8 years and above and persons with reduced physical, sensory or mental capabilities or lack of experience and knowledge if they have been given supervision or instruction by their guardians with relevant experience and knowledge concerning the use of the appliance in a safe way and understand the hazards involved.
- Juveniles and persons with reduced physical, sensory or mental capabilities shall be kept away unless continuously supervised by their guardians.
- Do not let juveniles play with the appliance.
- Keep detergents away from juveniles.
- Keep juveniles and pets away from the appliance when the door is open.
- Juveniles and persons with reduced physical, sensory or mental capabilities or lack of experience and knowledge shall not carry out cleaning and user maintenance of the appliance.

GENERAL SAFETY

- This appliance is for household use only.
- Do not change the specification of this appliance.

- The appliance maximum load is 7 kg. Do not exceed the maximum load of each programme (refer to the "Programmes" chapter).
- The operating water pressure at the water entry point from the outlet connection must be between 0.5 bar (0.05 MPa) and 8 bar (0.8 MPa).
- The ventilation opening in the base must not be covered by a carpet, mat, or any floor covering.
- The appliance must be connected to the water mains using the new supplied hose sets, or other new hose sets supplied by the Authorised Service Centre.
- Old hose sets must not be reused.
- If the mains power supply cable is damaged, it must be replaced by the manufacturer, its Authorised Service Centre or similarly qualified persons to avoid an electrical hazard.
- Before any maintenance operation, deactivate the appliance and disconnect the mains plug from the socket.
- Do not use high pressure water sprays and/or steam to clean the appliance.
- Clean the appliance with a moist cloth. Use only neutral detergents. Do not use abrasive products, abrasive cleaning pads, solvents or metal objects.

SAFETY INSTRUCTIONS

INSTALLATION



The installation must comply with relevant national regulations.

- Remove all the packaging and the transit bolts including rubber bush with plastic spacer.
- Keep the transit bolts in a safe place. If the appliance is to be moved in the future they must be reattached to lock the drum to prevent an internal damage.
- Always take care when moving the appliance as it is heavy. Always use safety gloves and enclosed footwear.
- Follow the installation instructions supplied with the appliance.
- Do not install or use a damaged appliance.
- Do not install or use the appliance where the temperature can be less than 0°C or where it is exposed to the weather.
- The floor area on which the appliance is to be installed must be flat, stable, heat resistant and clean.
- Make sure that there is air circulation between the appliance and the floor.
- When the appliance is in its permanent position, check if it is levelled correctly with the aid of a spirit level. If it is not, adjust the feet accordingly.
- Do not install the appliance directly above a floor drain.
- Do not spray water on the appliance and do not expose it to excessive humidity.
- Do not install the appliance where the appliance door cannot be fully opened.
- Do not put a closed container to collect possible water leakage under the appliance. Contact the Authorised Service Centre to ensure which accessories can be used.

ELECTRICAL CONNECTION



WARNING! Risk of fire and electric shock.

- The appliance must be earthed.
- Always use a correctly installed shockproof socket.
- Make sure that the parameters on the rating plate are compatible with the electrical ratings of the mains power supply.
- Do not use multi-plug adapters and extension cables.
- Make sure not to cause damage to the mains plug and to the mains cable. Should the mains cable need to be replaced, this must be carried out by our Authorised Service Centre.
- Connect the mains plug to the mains socket only at the end of the installation. Make sure that there is access to the mains plug after the installation.
- Do not touch the mains cable or the mains plug with wet hands.
- Do not pull the mains cable to disconnect the appliance. Always pull the mains plug.
- This appliance is fitted with a 13 A mains plug. If it is necessary to change the mains plug fuse, use only a 13 A ASTA (BS 1362) fuse.

WATER CONNECTION

- Do not cause damage to the water hoses.
- Before connection to new pipes, pipes not used for a long time, where repair work has been carried out or new devices fitted (water meters, etc.), let the water flow until it is clean and clear.
- Ensure that there are no visible water leaks during and after the first use of the appliance.
- Do not use an extension hose if the inlet hose is too short. Contact the Authorised Service Centre for the replacement of the inlet hose.
- When unpacking the appliance, It is possible to see water flowing from the drain hose. This is due to the testing of the appliance with the use of water in the factory.
- You can extend the drain hose to maximum 400 cm. Contact the Authorised Service Centre for the other drain hose and the extension.

INSTALLATION



WARNING! Refer to Safety chapters.

- Make sure that there is access to the tap after the installation.

USE



WARNING! Risk of injury, electric shock, fire, burns or damage to the appliance.

- Follow the safety instructions on the detergent packaging.
- Do not put flammable products or items that are wet with flammable products in, near or on the appliance.
- Do not wash fabrics which are heavily soiled with oil, grease or other greasy substances. It can damage rubber parts of the washing machine. Prewash such fabrics by hand before loading them into the washing machine.
- Do not touch the glass door while a programme operates. The glass can get hot.
- Make sure that all metal objects are removed from the laundry.

SERVICE

- To repair the appliance contact the Authorised Service Centre.
- Use original spare parts only.

DISPOSAL



WARNING! Risk of injury or suffocation.

- Disconnect the appliance from the mains electrical and water supplies.
- Cut off the mains electrical cable close to the appliance and dispose of it.
- Remove the door catch to prevent children or pets from becoming trapped in the drum.
- Dispose of the appliance in accordance with local requirements for the disposal of Waste Electrical and Electronic Equipment (WEEE).

UNPACKING

1. Remove the external film. If necessary, use a cutter.

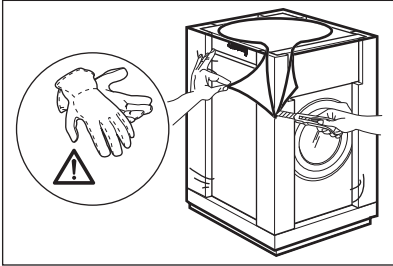

2. Remove the cardboard top and the polystyrene packaging materials.

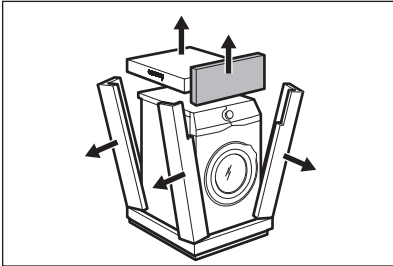

3. Open the door. Remove all the items from the drum.

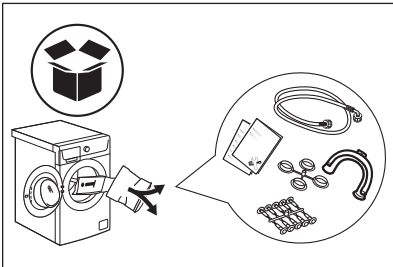

4. Put the front polystyrene packaging element on the floor behind the appliance. Carefully put down the appliance onto its rear side.

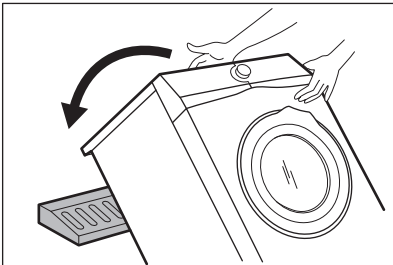

5. Remove the polystyrene protection from the bottom.

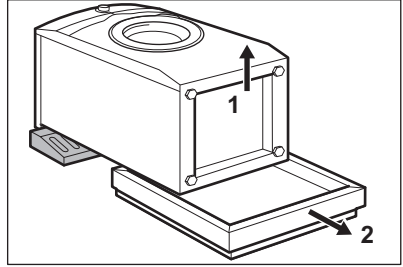

6. Remove the bottom cover from the worktop. Using clips fix, that you find in the user manual bag, attach the cover to the bottom of the appliance.

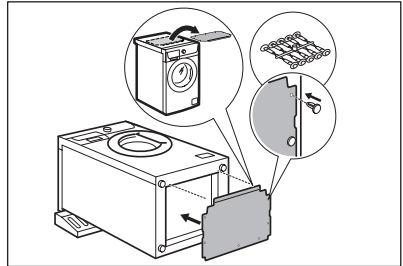

7. Put the appliance back into an upright position. Remove the power supply cable and the drain hose from the hose holder.

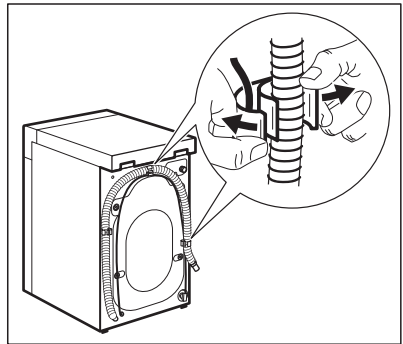

WARNING! It is possible to see water flowing from the drain hose. This is because the washing machine has been tested at the factory.

- Remove the four transit bolts and pull out the plastic spacers.

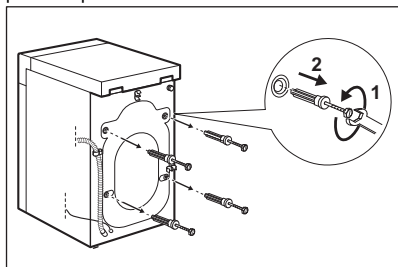

- Put the plastic caps, that you find in the user manual bag, in the holes.

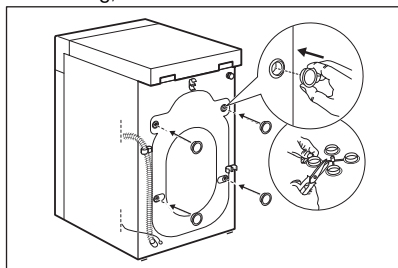

i We recommend that you keep the packaging and the transit bolts for any transport of the appliance.

INFORMATION FOR INSTALLATION

Positioning and levelling

Adjust the appliance correctly to prevent vibration, noise and movement of the appliance when it operates.

- Install the appliance on a flat hard floor. The appliance must be levelled and stable. Make sure that the appliance does not touch the wall or other units and there is air circulation below the appliance.
- Loosen or tighten the feet to adjust the level. All feet must rest firmly on the floor.



WARNING! Do not put cardboard, wood or equivalent materials below the appliance feet to adjust the level.

The inlet hose



CAUTION! Make sure there is no damage to hoses and there are no leaks from the couplings. Do not use an extension hose if the inlet hose is too short. Contact the service centre for a replacement inlet hose.

- Connect the water inlet hose to the back of the appliance.

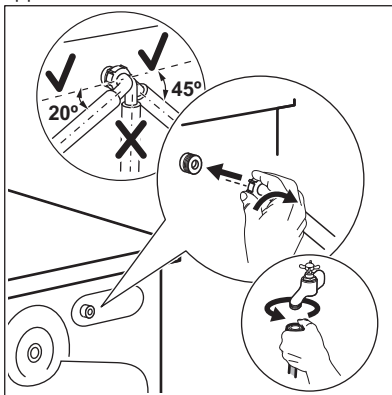

- Position it toward left or right depending on the position of the water tap. Make sure that the inlet hose is not in vertical position.
- If necessary, loosen the ring nut to set it in the correct position.
- Connect the water inlet hose to the cold water tap with 3/4" thread.

Water drainage

The drain hose should stay at a height of no less than 60 cm and not more than 100 cm.



You can extend the drain hose to maximum 400 cm. Contact the authorised service centre for the other drain hose and the extension.

It is possible to connect the drain hose in different ways:

- Make a U shape with the drain hose and put it around the plastic hose guide.

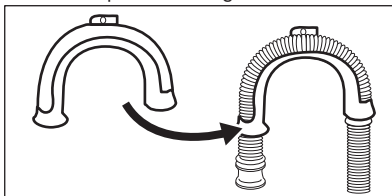

2. On the edge of a sink - Fasten the guide to the water tap or to the wall.

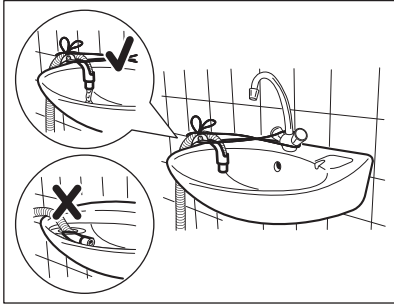

i Make sure that the plastic guide cannot move when the appliance drains and the drain hose end is not immersed in the water. There may be a return of dirty water into the appliance.

3. If the end of the drain hose looks like this (see the picture), you can push it directly into the stand

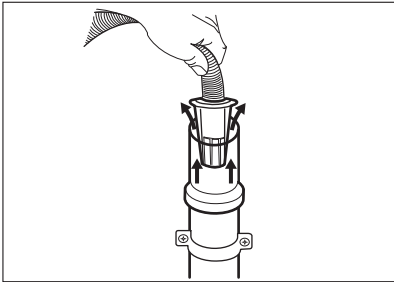

pipe.

4. To a stand pipe with vent-hole - Insert the drain hose directly into a drain pipe. Refer to the illustration.

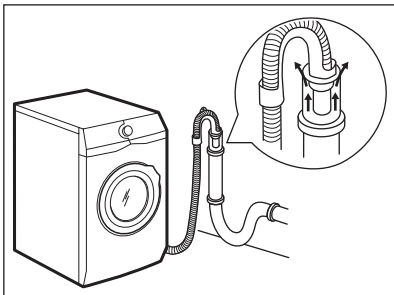

i The end of the drain hose must always be ventilated, i.e. the inner diameter of the drain pipe (min. 38 mm - min. 1.5") must be larger than the external diameter of the drain hose.

5. Without the plastic hose guide, to a sink spigot- Put the drain hose in the spigot and tighten it with a clamp. Refer to the illustration.

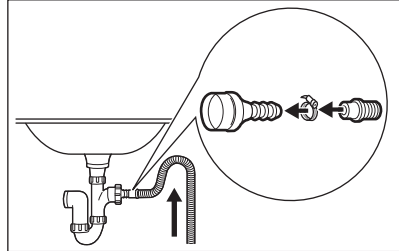

Make

sure that the drain hose makes a loop to prevent particles going into the appliance from the sink.

6. Position the hose directly to a built-in drain pipe in the room wall and tighten it with a clamp.

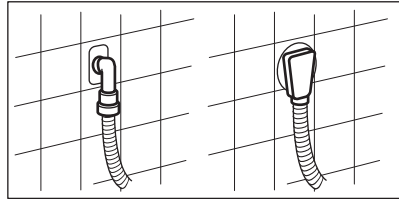

ELECTRICAL CONNECTION

At the end of installation you can connect the mains plug to the mains socket.

The rating plate and the 'Technical Data' chapter indicate the necessary electrical ratings. Make sure that they are compatible with the mains power supply.

Check that your domestic electrical installation can take the maximum load required, also taking into account any other appliances in use.

Connect the appliance to an earthed socket.

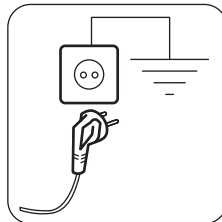

The power supply cable must be easily accessible after installing the appliance.

For any electrical work required to install this appliance, contact our Authorised Service Centre.

The manufacturer does not accept any responsibility for damage or injury through failure to comply with the above safety precaution.

PRODUCT DESCRIPTION

APPLIANCE OVERVIEW

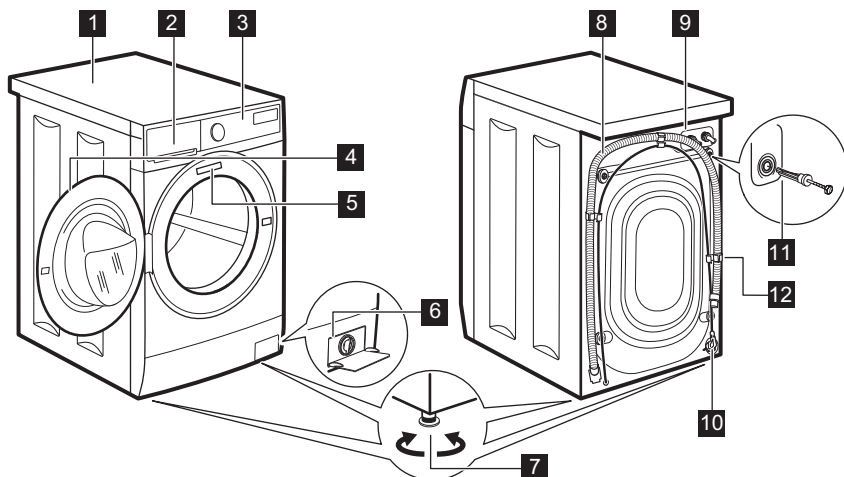

- 1** Worktop
- 2** Detergent dispenser
- 3** Control panel
- 4** Door handle
- 5** Rating plate
- 6** Drain pump filter
- 7** Feet for levelling the appliance
- 8** Drain hose
- 9** Inlet hose connection
- 10** Mains cable
- 11** Transit bolts
- 12** Hose support

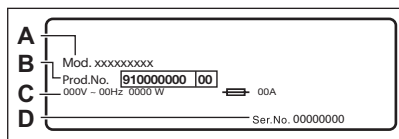

The rating plate reports the model name (**A**), product number (**B**), electrical ratings (**C**) and serial number (**D**).

CONTROL PANEL

SPECIAL FEATURES

Your new washing machine meets all modern requirements for an effective treatment of laundry

with low water, energy and detergent consumption and will care for fabrics.

The **AutoAdjust System** automatically adjusts the programme duration to the laundry in the drum to

achieve perfect washing results in the minimum possible. Read the paragraph "The AutoAdjust load detection" for more details.

CONTROL PANEL DESCRIPTION

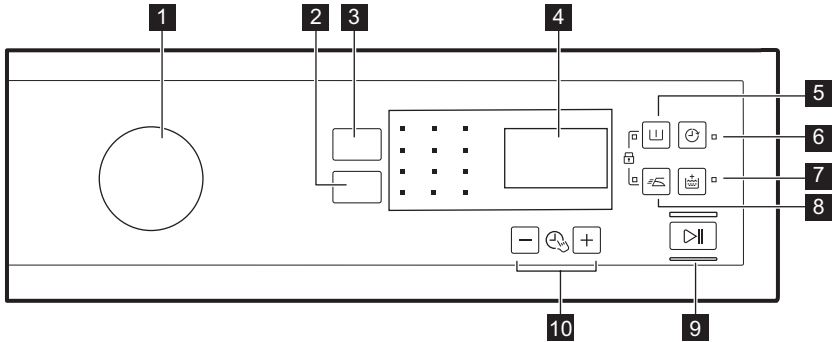

- | | |
|---|---|
| <ul style="list-style-type: none"> 1 Programme knob 2 Spin reduction touchpad 3 Temp touchpad 4 Display 5 Prewash touchpad 6 Delay Start touchpad | <ul style="list-style-type: none"> 7 Extra Rinse touchpad 8 Easy Iron touchpad 9 Start/Pause touchpad 10 FlexiTime touchpad |
|---|---|

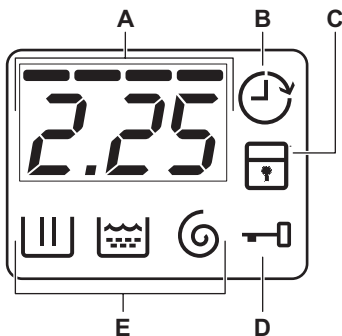

DISPLAY



- A.** The time area:
 - Programme time.
 - The alarm codes. Refer to the chapter "Troubleshooting" for their description.
 - The level of the FlexiTime -----.
- B.** The Delay Start indicator.
- C.** The Child Lock indicator.
- D.** The Door Lock indicator:
 - It is on, you cannot open the door.
 - It is off, you can open the door.
 - It flashes, you cannot open the door. Wait for some minutes until the indicator is off.
- E.** Washing phase indicators.
 - : the washing phase
 - : the rinses phase
 - : the spin phase

PROGRAMMES

PROGRAMME CHART

Programme Default temperature Temperature range	Reference spin speed Spin speed range	Maximum load	Programme description (Type of load and level of soiling)
Cottons 40°C 90°C - Cold	1200 rpm (1200- 400) rpm	7 kg	White cotton and coloured cotton. Normally, heavily and lightly soiled items.
Cotton Eco ¹⁾ 40°C 60°C - 40°C	1200 rpm (1200- 400) rpm	7 kg	White cotton and fast-coloured cotton. Normally soiled items. The energy consumption decreases and the time of the washing programme is extended, ensuring good washing results.
Synthetics 40°C 60°C - Cold	1200 rpm (1200- 400) rpm	3 kg	Synthetic items or mixed fabric items. Normally soiled items.
Delicates 40°C 40°C - Cold	1200 rpm (1200 -400)rpm	1,5 kg	Delicate fabrics such as acrylics, viscose and mixed fabrics requiring gentler washing. Normally and lightly soiled items.
 Wool 40°C 40°C - Cold	1200 rpm (1200- 400)rpm	1,5 kg 1200 rpm	Machine washable wool, hand washable wool and other fabrics with «hand washing» care symbol ²⁾ .
 Silk 30°C	800 rpm (800- 400)rpm	3 kg	Special programme for silk and mixed synthetic items.
Duvet 40°C 60°C - 30°C	800 rpm (800 - 400) rpm	2 kg	Special programme for one synthetic blanket, duvet, bedspread and so on.
Rinse Cold	1200 rpm (1200- 400) rpm	7 kg	To rinse and spin the laundry. All fabrics , except woollens and very delicate fabrics. Reduce the spin speed accordingly to the type of laundry.
Drain Cold	No Spin	7 kg	To drain the water in the drum. All fabrics.
Spin Cold	1200 rpm (1200- 400) rpm	7 kg	All fabrics, except woollens and delicate fabrics. To spin the laundry and to drain the water in the drum.
Jeans 40°C 60°C - Cold	1200 rpm (1200- 400) rpm	7 kg	Items in denim and jersey. Also for dark coloured items.









Programme Default temperature Temperature range	Reference spin speed Spin speed range	Maximum load	Programme description (Type of load and level of soiling)
Curtains 40°C 40°C - Cold	800 rpm (800- 400) rpm	1 kg	Special programme for curtains . The prewash phase is activated automatically. ³⁾
Refresh 30°C	800 rpm (800- 400) rpm	2 kg	Synthetic and delicate items . Lightly soiled items or items to refresh.
 Quick 30°C	800 rpm (800- 400) rpm	1 kg	Synthetic and mixed fabric items . Lightly soiled items and items to freshen up.









1) The programme at 60 °C with a load of 7 kg is the reference programme for energy label data, in compliance with IEC 60456.

2) During this cycle the drum rotates slowly to ensure a gentle wash. It can seem that the drum doesn't rotate or doesn't rotate properly, but this is normal for this programme.



3) Do not use any detergent for prewash phase to rinse only with water.

Programme options compatibility

Programme				 Prewash	 Delay Start	 Easy Iron	 Extra Rinse	FlexiTime
Cottons	■	■	■	■	■	■	■	■
Cotton Eco	■	■	■	■	■	■	■	■
Synthetics	■	■	■	■	■	■	■	■
Delicates	■	■	■	■	■	■	■	■
 Wool	■	■	■		■			
 Silk	■	■			■			
Duvet	■				■			
Rinse	■	■	■		■		■	
Drain					■			
Spin	■				■			
Jeans	■	■	■	■	■	■	■	■
Curtains	■	■	■		■	■	■	■
Refresh	■	■			■			

Programme				 Pre-wash	 Delay Start	 Easy Iron	 Extra Rinse	FlexiTime
Quick 	■	■			■			

Suitable detergents for washing programmes

Programme	Universal powder ¹⁾	Liquid Universal	Liquid for coloureds	Delicates woollens	Special
Cottons	▲	▲	▲	--	--
Cotton Eco	▲	▲	▲	--	--
Synthetics	▲	▲	▲	--	--
Delicates	--	--	--	▲	▲
 Wool	--	--	--	▲	▲
 Silk	--	--	--	▲	▲
Duvet	--	--	--	▲	▲
Jeans	--	--	▲	▲	▲
Curtains	--	--	--	▲	▲
Refresh	--	▲	▲	--	▲
Quick 	--	▲	▲	--	--

1) At temperature higher than 60 °C the use of powder detergent is recommended.

▲ = Recommended

-- = Not recommended

OPTIONS

TEMP

Set this option to change the default temperature.

Indicator  = cold water.

The indicator of the set temperature comes on.

SPIN

With this option you can change the default spin speed.

The indicator of the set speed comes on.

Additional spin options:

No Spin 

- Set this option to deactivate all spin phases. Only the drain phase is available.
- The related indicator comes on.
- Set this option for very delicate fabrics.
- The rinses phase uses more water for some washing programmes.

Rinse Hold

- Set this option to prevent the laundry creases.
- The related indicator comes on.
- There is a water in the drum when the programme is completed.
- The drum turns regularly to prevent the laundry creases.

- The door stays locked. You must drain the water to unlock the door.



To drain the water refer to 'At the end of the programme'.

PREWASH

With this option you can add a prewash phase to a washing programme.

Use this option for heavy soil.

When you set this option the programme duration increases.

The related indicator comes on.

DELAY START

With this option you can delay the start of a programme from 30 minutes to 20 hours.

The display shows the related indicator.

EXTRA RINSE

With this option you can add some rinses to a washing programme.

Use this option for persons allergic to detergents and in areas where the water is soft.

The related indicator comes on.

EASY IRON

The appliance carefully washes and spins the laundry to prevent the creases.

The appliance decreases the spin speed, uses more water and adapts the programme duration to the type of laundry.

The related indicator comes on.

FLEXITIME

With this option you can reduce the programme duration depending on the load size and the degree

of soiling. This adjustment should be made after the setting of Temp and Spin.

When you set a washing programme, the display shows the default duration and ----- dashes.

Touch FlexiTime button to reduce the programme duration according to your needs. The display shows the new programme duration and a number of dashes will decrease accordingly:

----- suitable for a full load of normally soiled garments.

---- a quick cycle for a full load of lightly soiled garments.

--- very quick cycle for a smaller lightly soiled load (max. half load recommended).

- the shortest cycle to freshen up a small amount of laundry.

The FlexiTime is available only with the programmes in the table.



indicator	Cotton Eco	Cottons	Synthetics	Delicates	Jeans	Curtains
-		■	■	■	■	■
--	■	■	■	■	■	■
---		■	■	■	■	■
----1)	■	■	■	■	■	■

1) Default duration for all programmes.

SETTINGS

CHILD LOCK

With this option you can prevent that the children play with the control panel.

- To **activate/deactivate** this option, press  and  at the same time until the indicator  comes on/goes off.



You can activate this option:

- After you press : the options and the programme knob are locked.

- Before you press : the appliance cannot start.

PERMANENT EXTRA RINSE

With this option you can permanently have an extra rinse when you set a new programme.

- To **activate/deactivate** this option press  and  at the same time until the indicator  comes on/goes off.

ACOUSTIC SIGNALS

The acoustic signals operate when:

- The programme is completed.
- The appliance has a malfunction.

To **deactivate/activate** the acoustic signals,

press  and  at the same time for 6 seconds.



If you deactivate the acoustic signals, they continue operate when the appliance has a malfunction.

BEFORE FIRST USE



During installation or before first use you may observe some water in the appliance. This is residual water left in the appliance after a full functional test in the factory to ensure the appliance is delivered to customers in perfect working order and is no cause for concern.

1. Connect the mains plug to the mains socket.
2. Open the water tap.

3. Put 2 litre of water in the detergent compartment for washing phase.

This activates the drain system.

4. Put a small quantity of detergent in the compartment for washing phase.
5. Set and start a programme for cotton at the highest temperature without laundry.

This removes all possible dirt from the drum and the tub.

DAILY USE



WARNING! Refer to Safety chapters.



CAUTION! Make sure that no laundry gets caught between the seal and the door to avoid risk of water leakage and damage to the laundry.

LOADING THE LAUNDRY

1. Open the appliance door.
2. Empty the pockets and unfold the items before you put them in the appliance.
3. Put the laundry in the drum, one item at a time.

Do not put too much laundry in the drum.

4. Close the door firmly.

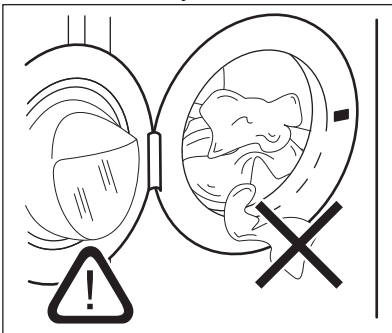

Washing heavily oiled, greasy stains could cause damage to rubber parts of the washing machine.

USING DETERGENT AND ADDITIVES

1. Measure out the detergent and the fabric conditioner.
2. Put the detergent and the fabric conditioner into the compartments.
3. Carefully close the detergent drawer

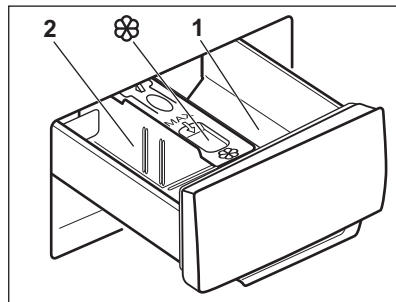



CAUTION! Use only specified detergents for washing machine.



Always obey the instructions that you find on the packaging of the detergent products.

1	Detergent compartment for pre-wash phase or soak programme (if available). Add the detergent for prewash and soak before the start of the programme.
2	Detergent compartment for washing phase. If you use a liquid detergent, put it immediately before you start the programme.
	Compartment for liquid additives (fabric conditioner, starch). Put the product in the compartment before you start the programme.

After a washing cycle, if necessary, remove any detergent residue from the detergent dispenser.

CHANGING POSITION OF DETERGENT DIVIDER

1. Pull out the detergent dispenser. The position **A** of the detergent divider is for **powder detergent** (factory setting).

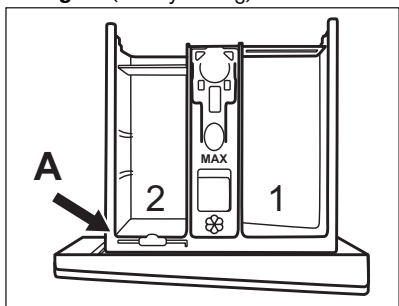

2. **To use also liquid detergent/additive or bleach:** Remove detergent divider from the position **A** and insert it in position **B**.

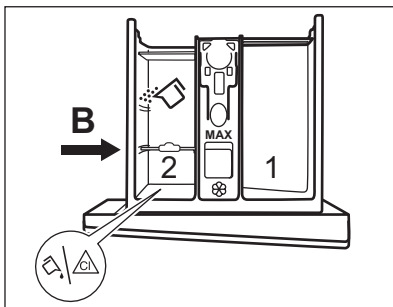

The position **B** of the detergent divider is for powder detergent in the rear compartment and for liquid detergent/additive or bleach in the front compartment.

3. **To use only liquid detergent:** Insert the detergent divider in position **C**.

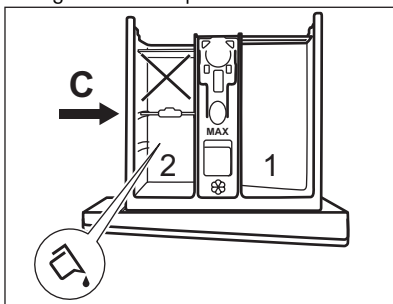

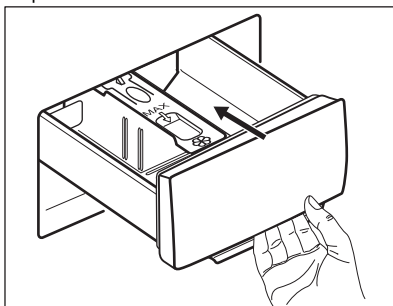

- Do not use gelatinous or thick liquid detergents.
 - Do not exceed the maximum dose of liquid detergent.
 - Do not set the prewash phase.
 - Do not set the delay start function.
4. Measure out the detergent and the fabric conditioner and carefully close the detergent dispenser.



Make sure that the detergent divider is inserted properly and does not cause a blockage when you close the drawer.



SETTING A PROGRAMME

1. Turn the programme knob and set the programme:
 - The indicator  flashes.
 - The display shows the level of the Time Manager, the programme duration and the indicators of the phases of the programme.
2. If necessary, change the temperature and the spin speed or add available options. When you activate an option, the indicator of the set option comes on.

 If you set something incorrect, the display shows the message .

STARTING A PROGRAMME WITHOUT THE DELAY START

Press .

- The indicator of  stops to flash and stays on.
- The indicator  starts to flash on the display.
- The programme starts, the door locks, the display shows the indicator .
- The drain pump can operate for a short time when the appliance fills water.



 After approximately 15 minutes from the start of the programme:

- The appliance adjusts automatically the programme duration agree with the laundry load.
- The display shows the new value.

STARTING A PROGRAMME WITH THE DELAY START





1. Press  again and again until the display shows the delay you want to set.

The related indicator comes on the display.

2. Press :
 - The appliance starts the countdown.
 - The door locks, the display shows the indicator .
 - When the countdown is completed, the programme starts automatically.

 You can cancel or change the set of the delay start before you press the

. To cancel the delay start:

- Press  to set the appliance to pause.
- Press  until the display shows .
- Press  again to start the programme immediately.

THE AUTOADJUST SYSTEM LOAD DETECTION

After touching the Start/Pause  button:

1. The AutoAdjust System starts estimating the weight of the load to calculate the real programme duration. During this phase the display shows the simple animation.
2. After about 10-15 minutes new cycle duration is displayed.
The appliance automatically adjusts the programme duration to the load to achieve perfect washing results in the minimum possible time.

 The AutoAdjust System is not available with all programmes such as :Wool, Rinse, SpinDrain, and programmes with short cycles.

INTERRUPTING A PROGRAMME AND CHANGING THE OPTIONS

You can change only some options before they operate.

1. Press .

The indicator flashes.

2. Change the options.

3. Press  again.

The programme continues.

CANCELLING A RUNNING PROGRAMME

1. Turn the programme knob to position  to cancel the programme and to deactivate the appliance.
2. Turn the programme knob again to activate the appliance. Now, you can set a new washing programme.



-  Before starting the new programme the appliance could drain the water. In this case, make sure that the detergent is still in the detergent compartment, if not fill the detergent again.



OPENING THE DOOR WHEN THE DELAY START OPERATES OR WHEN PROGRAMME STARTS TO OPERATE

While a delay start operates or when the programme has just started to operate, the appliance door is locked and the indicator  is on.

1. Press  to pause the appliance.

The indicator  starts flashing.

2. Wait about 2 minutes until the door lock indicator  stops flashing and goes off.
3. You can open the door.
4. Close the door and press the  again. The delay start or the programme continues to operate.

-  When the programme has already started and you pause the appliance, but the indicator  does not flash and the door cannot be opened, switch the appliance off to open the door. Please refer to "Opening the door when the programme operates".

OPENING THE DOOR WHEN THE PROGRAMME OPERATES

While a programme operates, the appliance door is locked and the indicator  is on.





CAUTION! If the temperature and level of the water in the drum are too high, you cannot open the door.



1. Turn the programme knob to position  to deactivate the appliance.
2. Wait for some minutes and then open the appliance door.
3. Close the appliance door.
4. Set the programme again.

AT THE END OF THE PROGRAMME



- The appliance stops automatically.
- The acoustic signal operates (if it is activated).
- In the display  comes on.

- The indicator of the  goes off.
- The door lock indicator  flashes for a few minutes, then goes off.
- You can open the door.
- Remove the laundry from the appliance. Make sure that the drum is empty.
- Close the water tap.
- Turn the programme knob to position On/Off to deactivate the appliance.
- Keep the door ajar, to prevent the mildew and odours.

The washing programme is completed, but there is water in the drum:

- The drum turns regularly to prevent the creases in the laundry.
- The door lock indicator  is on. The indicator  flashes. The door stays locked.
- You must drain the water to open the door.

To drain the water:

1. Press . The appliance drains the water and spins.
2. When the programme is completed, the door lock indicator  flashes for a few minutes. When it goes off, you can open the door.
3. Turn the programme knob to position On/Off to deactivate the appliance.



The appliance drains and spins automatically after approximately 18 hours (except for Wool programme).

STAND-BY

About 5 minutes after the end of the washing programme, if you do not deactivate the appliance, the energy saving status activates.

The energy saving status activates also during set up if no action occurs for about 5 minutes.

The energy saving status decreases the energy consumption when the appliance is on the stand by.

- All indicators go off.
- The indicator of the  flashes slowly .
- Press one of the options to deactivate the energy saving status.



If you set a programme or an option that ends with water in the drum, the energy saving status function **doesn't activate** to remind you to drain the water.

HINTS AND TIPS

THE LAUNDRY LOAD

- Divide the laundry in: white, coloured, synthetics, delicates and wool.
- Obey the washing instructions that are on the laundry care labels.
- Do not wash white and coloured items together.
- Some coloured items can discolour with the first wash. We recommend that you wash them separately for the first times.
- Turn multilayered fabrics, wool and items with painted illustrations inside out.
- Wash and pre-treat heavy soil stains with a suitable detergent before putting in drum.
- Be careful with the curtains. Remove the hooks and put the curtains in a washing bag or pillowcase.
- Do not wash laundry without hems or with cuts. Use a washing bag to wash small and/or delicate items (e.g. underwired bras, belts, tights, shoelaces, ribbons, etc.).

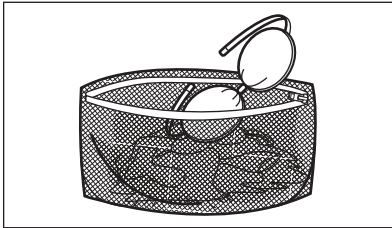

- A very small load can cause balance problems with the spin phase leading to excessive vibration. If this occurs:
 - interrupt the programme and open the door (refer to "Daily Use" chapter);
 - manually redistribute the load so that the items are spaced evenly around the tub;
 - press the Start/Pause button. The spin phase continues.
- Button up pillowcases, close zippers, hooks and poppers. Tie up belts, cords, shoelaces, ribbons and any other loose elements.
- Empty the pockets and unfold the items.

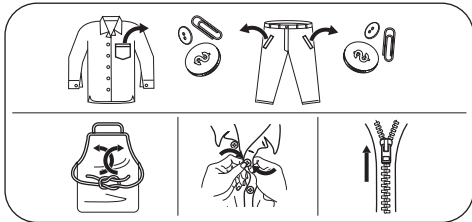

STUBBORN STAINS

For some stains, water and detergent is not sufficient.

We recommend that you pre-treat these stains before you put the items in the appliance.

Special stain removers are available. Use the special stain remover that is applicable to the type of stain and fabric.

DETERGENT TYPE AND QUANTITY.

The choice of detergent and use of correct quantities not only affects your wash performance, but also helps to avoid waste and protect the environment:

- Use only detergents and other treatments specially made for washing machines. First, follow these generic rules:
 - powder detergents for all types of fabric, excluding delicate. Prefer powder detergents containing bleach for whites and laundry sanitization,
 - liquid detergents, preferably for low temperature wash programmes (60 °C max) for all types of fabric, or special ones for woollens only.
- The choice and quantity of detergent will depend on: type of fabric (delicates, woollens, cottons, etc), the colour of clothes, size of the load, degree of soiling, wash temperature and hardness of the water used.
- Follow the instructions that you find on packaging of the detergents or other treatments without exceeding the indicated maximum level (**MAX**).
- Do not mix different types of detergents.
- Use less detergent if:
 - you are washing a small load,
 - the laundry is lightly soiled,
 - there is large amounts of foam during washing.
- When using detergent tabs or pods, always put them inside the drum, not in the detergent dispenser.

Insufficient detergent may cause:

- unsatisfactory washing results,
- the wash load to turn grey,
- greasy clothes,
- mould in the appliance.

Excessive detergent may cause:

- sudsing,
- reduced washing effect,
- inadequate rinsing,
- a greater impact for the environment.

ECOLOGICAL HINTS

To save water, energy and to help protect the environment, we recommend that you follow these tips:

- **Normally soiled laundry** may be washed **without prewash** in order to save detergent, water and time (the environment is protected too!).
- Loading the appliance to the **maximum capacity indicated for each programmes helps to reduce energy and water consumption.**
- With adequate pre-treatment, stains and limited soiling can be removed; the laundry can then be washed at a lower temperature.
- To use the correct quantity of detergent, refer to the quantity suggested by the detergent producer and check the water hardness of your domestic system. Refer to "Water hardness".

CARE AND CLEANING



WARNING! Refer to Safety chapters.

PERIODIC CLEANING SCHEDULE

Periodic cleaning helps to extend the life of your appliance.

After each cycle, keep the door and the detergent dispenser slightly ajar to get air circulation and dry the humidity inside the appliance: this will prevent mildew and odours.

If the appliance is not used for a long time: close the water tap and unplug the appliance.

Indicative periodic cleaning schedule:

Descaling	Twice a year
Maintenance wash	Once a month
Clean door seal	Every two months
Clean drum	Every two months
Clean detergent dispenser	Every two months
Clean drain pump filter	Twice a year
Clean the inlet hose and the valve filter	Twice a year

The following paragraphs explain how you should clean each part.

- Set the **maximum possible spin speed** for the selected washing programme **before drying your laundry in a tumble dryer.** This will save energy during drying!

WATER HARDNESS

If the water hardness in your area is high or moderate, we recommend that you use a water softener for washing machines. In areas where the water hardness is soft it is not necessary to use a water softener.

To know the water hardness in your area, contact your local water authority.

Use the correct quantity of the water softener.

Obey the instructions that you find on the packaging of the product.

REMOVING FOREIGN OBJECTS



Make sure that pockets are empty and all loose elements are tied up before running your cycle. Refer to 'The laundry load' in 'Hints and tips'.

Remove any foreign objects (such as metal clip, buttons, coins, etc) that you may find in the door seal, the filters and the drum. Refer to 'Door seal with double lip trap', 'Cleaning the drum', 'Cleaning the drain pump' and 'Cleaning the inlet hose and the valve filter' paragraphs. If necessary, please contact the Authorised Service Centre.

EXTERNAL CLEANING

Clean the appliance with mild soap and warm water only. Fully dry all the surfaces. Do not use a scouring pads or any scratching material.



CAUTION! Do not use alcohol, solvents or chemical products.



CAUTION! Do not clean the metal surfaces with chlorine-based detergent.

DESCALING

If the water hardness in your area is high or moderate, we recommend that you use a water descaling product for washing machines.

Regularly examine the drum to prevent limescale and rust particles.

To remove rust particles use only special products for washing machines. Do this separately from the laundry wash.

i Always obey the instructions that you find on the packaging of the product.

MAINTENANCE WASH

With the low temperature programmes it is possible that some detergent stays in the drum. Perform a maintenance wash regularly. To do this:

- Remove all laundry from the drum.
- Select the cotton programme with the highest temperature with a small quantity of detergent.

DOOR SEAL WITH DOUBLE LIP TRAP

This appliance is designed with a **self cleaning draining system**, allowing light fluff fibers that fall off the clothes to be drained out with the water. Regularly examine the seal. Coins, buttons, other small items can be recovered at the end of the cycle.

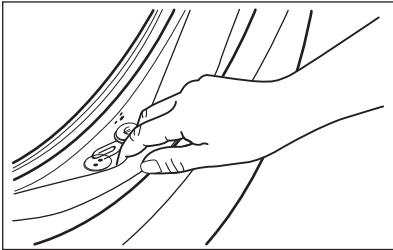

Clean it when needed, using ammonia cream cleanser agent without scratching the seal surface.

i Always obey the instructions that you find on the packaging of the product.

Check and remove objects (if there are any) that could be trapped in the fold.

Make sure that no laundry remains between the seal and the door.

Use a moist cloth to wipe off any dirt or water residue left behind in the door seal after completion of program cycle.

CLEANING THE DRUM

Regularly examine the drum to prevent rust forming. Clean the drum with special products for stainless steel.

i Always follow the instructions that you find on the packaging of the product.

For a thorough clean:

- Remove all laundry from the drum.
- Run a Cottons programme with the highest temperature. Add a small quantity of powder detergent into the empty drum, in order to rinse out any left residues.

CLEANING THE DETERGENT DISPENSER

To prevent possible deposits of dried detergent or clotted fabric softener and/or formation of mould in the detergent dispenser drawer, once in a while carry out the following cleaning procedure:

1. Open the drawer. Press the catch downwards as indicated in the picture and pull it out.

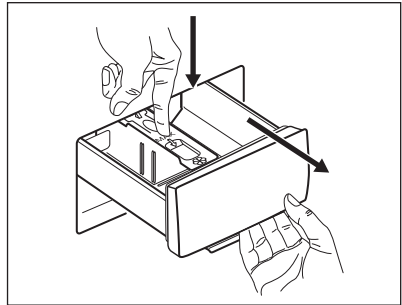

2. Remove the top part of the additive compartment to aid cleaning and flush it out under running warm water, to remove any traces of accumulated detergent. After cleaning, put the top part back into position.

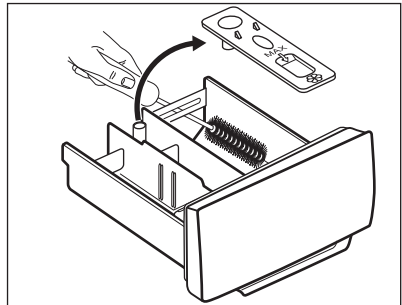

3. Make sure that all detergent residue is removed from the upper and lower part of the recess.

Use a small brush to clean the recess.

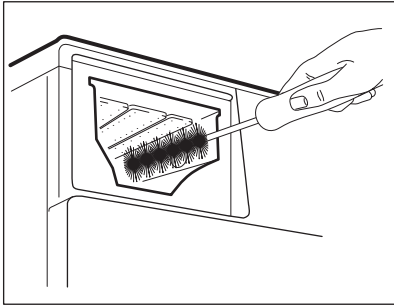

without any clothes in the drum.

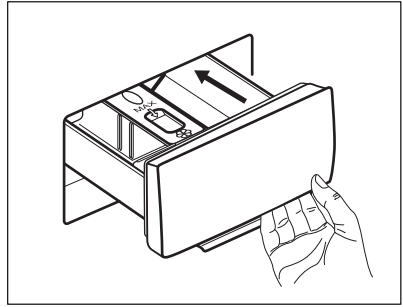

4. Insert the detergent drawer into the guide rails and close it. Run the rinsing programme

CLEANING THE DRAIN PUMP

Regularly check the drain pump filter and make sure that it is clean.

Clean the drain pump if:

- The appliance does not drain the water.
- The drum does not turn.
- The appliance makes an unusual noise because of the blockage of the drain pump.
- The display shows the alarm code **E20**



WARNING!

- Disconnect the mains plug from the mains socket.
- Do not remove the filter while the appliance operates.
- Do not clean the pump if the water in the appliance is hot. Wait until the water cools down .
- Repeat Step 3 several times by closing and opening the valve until the water stops flowing out.

Always keep a rag nearby to dry up any water spillages when removing the filter.

Proceed as follows to clean the pump:

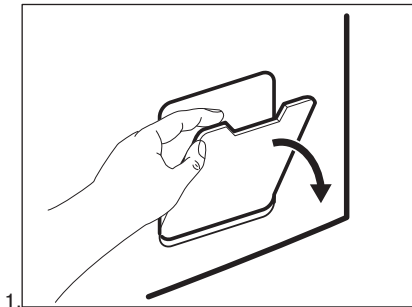

1.

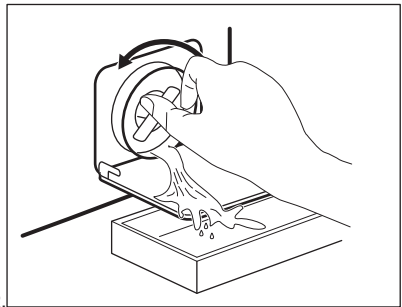

2.

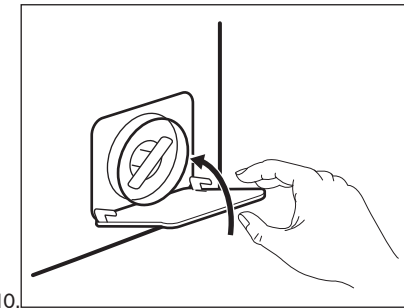
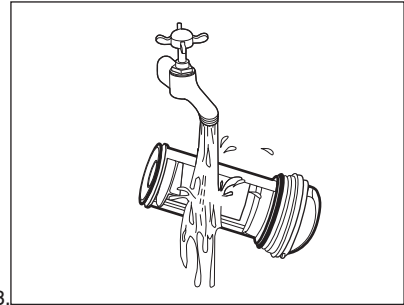
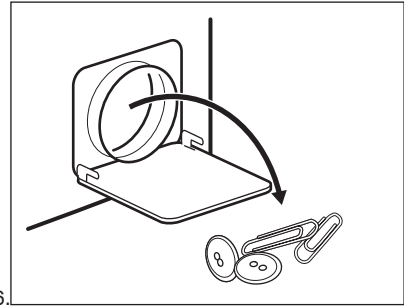
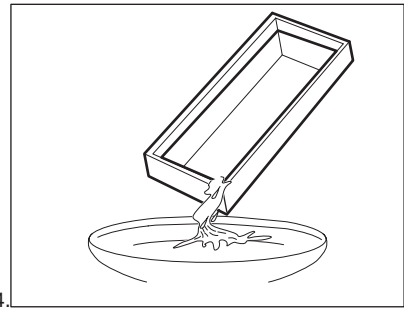
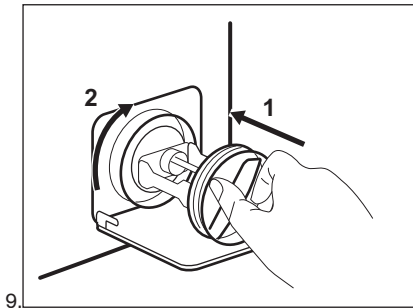
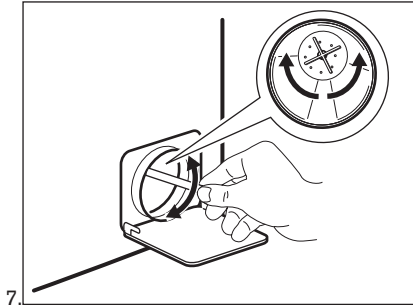
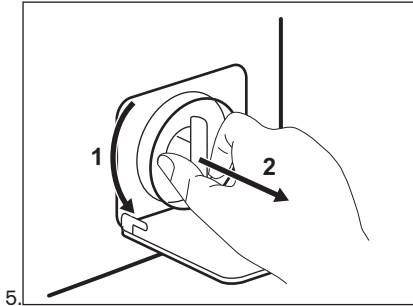
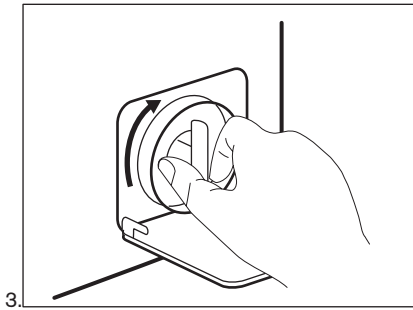

WARNING! Make sure that the impeller of the pump can rotate. If it does not rotate, contact the Authorised Service Centre. Make sure also that you tighten the filter correctly to prevent leakages.

When you drain the water with the emergency drain procedure, you must activate the drain system again:

1. Put 2 litres of water in the main wash compartment of the detergent dispenser.
2. Start the programme to drain the water.

CLEANING THE INLET HOSE AND THE VALVE FILTER

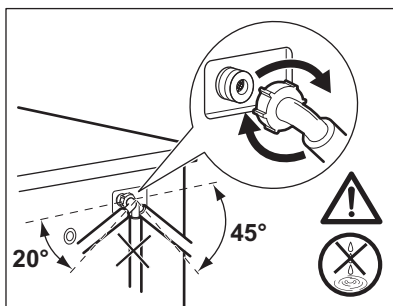
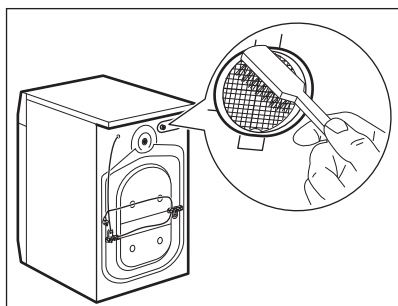
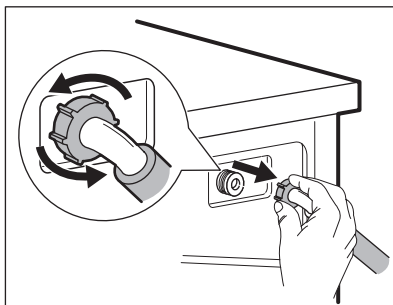
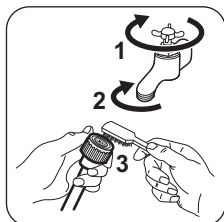

EMERGENCY DRAIN

Because of a malfunction, the appliance cannot drain the water.

If this occurs, do steps (1) through (10) of 'Cleaning the drain filter'. If necessary, clean the pump.

When you drain the water with the emergency drain procedure, you must activate again the drain system:

1. When you drain the water with the emergency drain procedure, you must activate again the drain system: Put 2 litres of water in the main wash compartment of the detergent dispenser.
2. Start the programme to drain the water

FROST PRECAUTIONS

If the appliance is installed in an area where the temperature can be less than 0° C, remove the

remaining water from the inlet hose and the drain pump.

1. Disconnect the mains plug from the mains socket.
2. Close the water tap.
3. Put the two ends of the inlet hose in a container and let the water flow out of the hose.
4. Empty the drain pump. Refer to the emergency drain procedure.
5. When the drain pump is empty, install the inlet hose again.



WARNING! Make sure that the temperature is higher than 0 °C before you use the appliance again. The manufacturer is not responsible for damages caused by low temperatures.

TROUBLESHOOTING



WARNING! Refer to Safety chapters.

ALARM CODES AND POSSIBLE FAILURES

The appliance does not start or it stops during operation. First try to find a solution to the problem (refer to the tables).



WARNING! Deactivate the appliance before carrying out any check.

With some problems, the display shows an alarm code and the Start/ Pause button may flash continuously:

Problem	Possible solution
E 10 The appliance does not fill with water properly.	<ul style="list-style-type: none">▪ Make sure that the water tap is open.▪ Make sure that the pressure of the water supply is not too low. For this information, contact your local water authority.▪ Make sure that the water tap is not clogged.▪ Make sure that the inlet hose has no kinks, damages or bends.▪ Make sure that the connection of the water inlet hose is correct.▪ Make sure that the filter of the inlet hose and the filter of the valve are not clogged. Refer to 'Care and cleaning'.
E20 The appliance does not drain the water.	<ul style="list-style-type: none">▪ Make sure that the sink spigot is not clogged.▪ Make sure that the drain hose has no kinks or bends.▪ Make sure that the drain filter is not clogged. Clean the filter, if necessary. Refer to "Care and cleaning".▪ Make sure that the connection of the drain hose is correct.▪ Set the drain programme if you set a programme without drain phase.▪ Set the drain programme if you set an option which ends with water in the tub.
E40 The appliance door is open or not closed correctly.	<ul style="list-style-type: none">▪ Make sure that the door is properly closed.
E9 1 Internal fail. No communication between electronic elements of the appliance.	<ul style="list-style-type: none">▪ The programme was not finished properly or the appliance stopped too early. Switch the appliance off and on again.▪ If the alarm code appears again, contact the Authorised Service Centre.
E40 The mains supply is unstable.	<ul style="list-style-type: none">▪ Wait until mains supply is stable.

If the display shows other alarm codes, deactivate and activate the appliance. If the problem continues, contact the Authorised Service Centre.

In case of different problem with the washing machine check the table below for possible solutions.

Problem	Possible solution
The programme does not start.	<ul style="list-style-type: none"> ▪ Make sure that the mains plug is connected to the mains socket. ▪ Make sure that the appliance door is closed. ▪ Make sure that there is no damaged fuse in the fuse box. ▪ Make sure that the Start/Pause has been touched. ▪ If the delay start is set, cancel the setting or wait for the end of count-down. ▪ Deactivate the Child Lock function if it is on. ▪ Check the position of the knob on the selected programme.
The appliance fills with water and drains immediately.	<ul style="list-style-type: none"> ▪ Make sure that the drain hose is in the correct position. The hose may be positioned too low. Refer to "Installation instruction".
The spin phase does not operate or the washing cycle lasts longer than usual.	<ul style="list-style-type: none"> ▪ Set the spin programme. ▪ Make sure that the drain filter is not clogged. Clean the filter, if necessary. Refer to "Care and cleaning". ▪ Adjust manually the items in the tub and start the spin phase again. This problem may be caused by balance problems.
There is water on the floor.	<ul style="list-style-type: none"> ▪ Make sure that the couplings of the water hoses are tight and there is not water leakages. ▪ Make sure that the water inlet hose and the drain hose have no damages. ▪ Make sure you use the correct detergent and the correct quantity of it.
You cannot open the appliance door.	<ul style="list-style-type: none"> ▪ Make sure that a washing programme that ends with water in tub, has not been selected. ▪ Make sure that the washing programme is finished. ▪ Set the drain or the spin programme if there is water in the drum.
The appliance makes an unusual noise and vibrates.	<ul style="list-style-type: none"> ▪ Make sure the levelling of the appliance is correct. Refer to "Installation instruction". ▪ Make sure that the packaging and/or the transit bolts are removed. Refer to "Installation instruction". ▪ Add more laundry in the drum. The load may be too small.
The programme duration increases or decreases during programme execution.	<ul style="list-style-type: none"> ▪ The AutoAdjust System is able to adjust the programme duration according to the type and the laundry load size. Refer to "The AutoAdjust System load detection" in "Daily Use" chapter.
The washing results are not satisfactory.	<ul style="list-style-type: none"> ▪ Increase the detergent quantity or use a different detergent. ▪ Use special products to remove the stubborn stains before you wash the laundry. ▪ Make sure that you set the correct temperature. ▪ Decrease the laundry load.
Too much foam in the drum during the washing cycle.	<ul style="list-style-type: none"> ▪ Reduce the quantity of detergent.
After the washing cycle, there are some detergent residues in the dispenser drawer.	<ul style="list-style-type: none"> ▪ Make sure that the flap is in the correct position (UP for powder detergent - DOWN for liquid detergent). ▪ Make sure you have used the detergent dispenser according the indications given in this user manual.

After the check, activate the appliance. The programme continues from the point of interruption.

If the problem occurs again, contact the Authorised Service Centre.

The necessary data for the service centre are on the rating plate.

SERVICE

We recommend the use of original spare parts.
When contacting the Authorised Service Centre, make sure that these data are available. You can

find the information on the rating plate: model, PNC and Serial Number. (Mod., Prod. No., Ser. No.)

TECHNICAL DATA

Dimension	Width/ Height/ Total depth	595 mm / 843 mm / 488 mm
Electrical connection	Voltage Overall power Fuse Frequency	220 V 2000 W 13 A 50 Hz
Level of protection against ingress of solid particles and moisture ensured by the protective cover, except where the low voltage equipment has no protection against moisture		IPX4
Water supply pressure	Minimum Maximum	0.5 bar (0.05 MPa) 8 bar (0.8 MPa)
Water supply ¹⁾		Cold water
Maximum Load	Cotton	7 kg
Spin Speed	Maximum spin speed	1200 rpm

1) Connect the water inlet hose to a water tap with a 3/4" thread.

ENVIRONMENTAL CONCERNS

Recycle materials with the symbol . Put the packaging in relevant containers to recycle it. Help protect the environment and human health by recycling waste of electrical and electronic appliances. Do not dispose of appliances marked

with the symbol  with the household waste. Return the product to your local recycling facility or contact your municipal office.

WWW.ZANUSSI.COM/SHOP



CE

155281960-A-232021