

User Manual

GETTING STARTED? EASY.



ZWQ71236SE

EN User Manual
Washing Machine

ZANUSSI

SAFETY INFORMATION

Before the installation and use of the appliance, carefully read the supplied instructions. The manufacturer is not responsible for any injuries or damages that are the result of incorrect installation or usage. Always keep the instructions in a safe and accessible location for future reference.

CHILDREN AND VULNERABLE PEOPLE SAFETY

- This appliance can be used by children aged from 8 years and above and persons with reduced physical, sensory or mental capabilities or lack of experience and knowledge if they have been given supervision or instruction concerning the use of the appliance in a safe way and understand the hazards involved.
- Do not let children play with the appliance.
- Children aged 3 years and under must be kept away from this appliance when it is in operation at all times.
- Keep all packaging away from children and dispose of it appropriately.
- Keep detergents away from children.
- Keep children and pets away from the appliance door when it is open.
- Children shall not carry out cleaning and user maintenance of the appliance without supervision.

GENERAL SAFETY

- Do not change the specification of this appliance.
- Do not exceed the maximum load of 7 kg (refer to the "Programme chart" chapter).
- The operating water pressure at the water entry point from the outlet connection must be between 0.5 bar (0.05 MPa) and 8 bar (0.8 MPa).
- The ventilation opening in the base (if applicable) must not be covered by a carpet, mat, or any floor covering.
- The appliance must be connected to the water mains using the new supplied hose sets, or other new hose sets supplied by the Authorised Service Centre.

- Old hose sets must not be reused.
- If the mains power supply cable is damaged, it must be replaced by the manufacturer, its Authorised Service Centre or similarly qualified persons to avoid an electrical hazard.
- Before any maintenance operation, deactivate the appliance and disconnect the mains plug from the socket.
- Do not use high pressure water sprays and/or steam to clean the appliance.
- Clean the appliance with a moist cloth. Use only neutral detergents. Do not use abrasive products, abrasive cleaning pads, solvents or metal objects.

SAFETY INSTRUCTIONS

INSTALLATION

- Remove all the packaging and the transit bolts.
- Keep the transit bolts in a safe place. If the appliance is to be moved in future they must be reattached to lock the drum to prevent internal damage.
- Always take care when moving the appliance as it is heavy. Always use safety gloves and enclosed footwear.
- Do not install or use a damaged appliance.
- Follow the installation instruction supplied with the appliance.
- Do not install or use the appliance where the temperature can be less than 0°C or where it is exposed to the weather.
- The floor area where the appliance is to be installed must be flat, stable, heat resistant and clean.
- Make sure that there is air circulation between the appliance and the floor.
- Adjust the feet to have the necessary space between the appliance and the flooring.
- Do not install the appliance where the appliance lid cannot be fully opened.
- Do not put a container to collect possible water leakage under the appliance. Contact the Authorised Service Centre to ensure which accessories can be used.

ELECTRICAL CONNECTION

- The appliance must be earthed.
- Always use a correctly installed shockproof socket.
- Make sure that the parameters on the rating plate are compatible with the electrical ratings of the mains power supply.

- Do not use multi-plug adapters and extension cables.
- Make sure not to cause damage to the mains plug and to the mains cable. Should the mains cable need to be replaced, this must be carried out by our Authorised Service Centre.
- Connect the mains plug to the mains socket only at the end of the installation. Make sure that there is access to the mains plug after the installation.
- Do not touch the mains cable or the mains plug with wet hands.
- Do not pull the mains cable to disconnect the appliance. Always pull the mains plug.
- This appliance complies with the E.E.C. Directives.

WATER CONNECTION

- Do not cause damage to the water hoses.
- Before connection to new pipes, pipes not used for a long time, where repair work has been carried out or new devices fitted (water meters, etc.), let the water flow until it is clean and clear.
- Ensure that there are no visible water leaks during and after the first use of the appliance.

USE



WARNING! Risk of injury, electrical shock, fire, burns or damage to the appliance.

- This appliance is for household use only.
- Follow the safety instructions on the detergent packaging.

- Do not put flammable products or items that are wet with flammable products in, near or on the appliance.
- Make sure that all metal objects are removed from the laundry.

SERVICE

- To repair the appliance contact an Authorised Service Centre.
- Use original spare parts only.

DISPOSAL



WARNING! Risk of injury or suffocation.

- Disconnect the appliance from the mains electrical and water supplies.
- Cut off the mains electrical cable close to the appliance and dispose of it.
- Remove the door catch to prevent children or pets from becoming trapped in the drum.
- Dispose of the appliance in accordance with local requirements for the disposal of Waste Electrical and Electronic Equipment (WEEE).

PRODUCT DESCRIPTION

APPLIANCE OVERVIEW

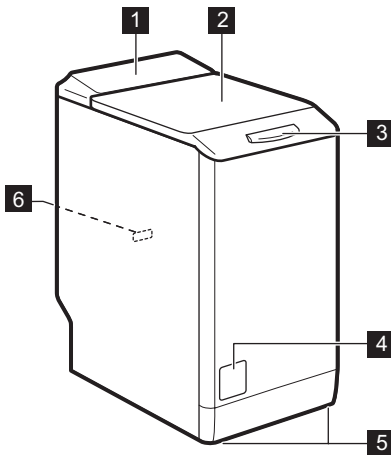

- 1** Control panel
- 2** Lid
- 3** Push handle
- 4** Drain pump filter
- 5** Feet for levelling the appliance
- 6** Rating plate

CONTROL PANEL

CONTROL PANEL DESCRIPTION

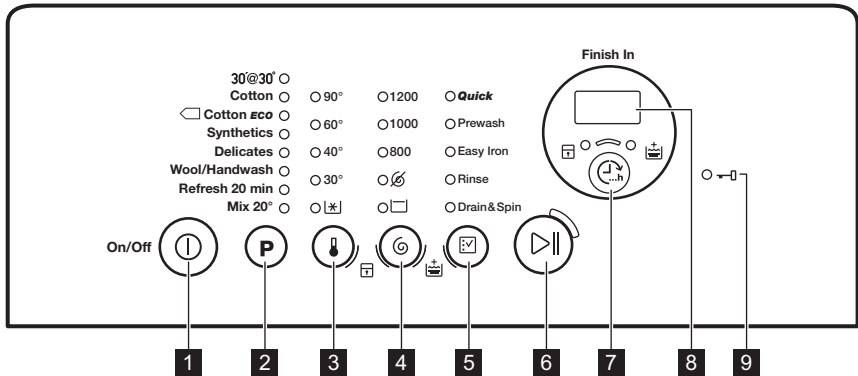

- 1** On/Off button On/Off
- 2** Programs selection touchpad **P**
- 3** Temperature selection touchpad
- 4** Spin selection touchpad
- 5** Options selection touchpad
- 6** Start/Pause touchpad
- 7** Finish In touchpad
- 8** Display
- 9** Door locked indicator

DISPLAY

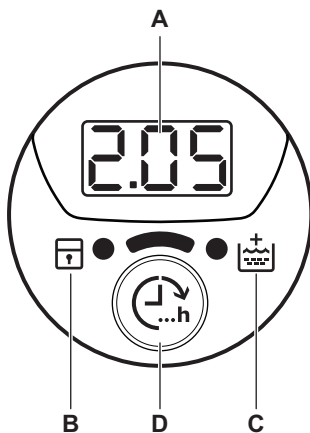

- A.** The time area:
 - **1:25**: the programme duration
 - **3h**: the "finish in" time
 - **E20**: the alarm codes
 - **E r r**: the message of error
 - **0**: the programme is completed.
- B.** The child lock indicator:
 - The indicator comes on when you activate this device.
- C.** The extra rinse indicator:
 - The indicator comes on when you activate this option.
- D.** The Finish In touchpad.

PROGRAMME CHART

Programme Temperature range	Maximum load Maximum spin speed	Programme description (Type of load and soil level)
30'@30° 30°C	2 kg 800 rpm	A short cycle for synthetic and delicate items with light soil level or for items to freshen up.
Cotton 90°C - Cold	7 kg 1200 rpm	White cotton and coloured cotton. Normal soil and light soil.
 Cotton ECO ¹⁾ 60°C - 40°C	7 kg 1200 rpm	White cotton and fast-coloured cotton. Normal soil. The energy consumption decreases and the time of the washing programme is extended.
Synthetics 60°C - Cold	3 kg 1200 rpm	Synthetic items or mixed fabric items. Normal soil.
Delicates 40°C - Cold	2,5 kg 1200 rpm	Delicate fabrics such as acrylics, viscose, polyester items. Normal soil.
Wool/Handwash 40°C - Cold	1 kg 1200 rpm	Machine washable wool, hand washable wool and delicate fabrics with «hand washing» care symbol. ²⁾
Refresh 20 min 40°C - 30°C	1 kg 1200 rpm	A very short cycle for cotton and synthetic items with light soil level or worn only once.
Mix 20° 20°C	2,5 kg 1200 rpm	Special programme for cotton, synthetic and mixed fabrics with light soil. Set this programme to decrease the energy consumption. Make sure that the detergent is for low temperature in order to have good washing results ³⁾ .





1) Standard programmes for the Energy Label consumption values. According to regulation 1061/2010, these programmes are respectively the «Standard 60°C cotton programme» and the «Standard 40°C cotton programme». They are the most efficient programmes in terms of combined energy and water consumption for washing normally soiled cotton laundry.



The water temperature of the washing phase may differ from the temperature declared for the selected programme.

- 2)** During this cycle the drum rotates slowly to ensure a gentle wash. It can seem that the drum doesn't rotate or doesn't rotate properly, but this is normal for this programme.
- 3)** No temperature indicator is on .

Programme options compatibility

Programme				Quick ¹⁾	Prewash	Easy Iron	Rinse	Drain & Spin		
30'@30°		■					■	■	■	
Cotton	■	■	■	■	■	■	■	■	■	■
Cotton ECO	■	■	■	■	■		■	■	■	■
Synthetics	■	■	■	■	■	■	■	■	■	■
Delicates	■	■	■	■	■		■	■	■	■
Wool/Hand-wash	■	■	■				■	■	■	
Refresh 20 min	■	■	■				■	■	■	
Mix 20°	■	■	■				■	■	■	

1) When you set this option, we recommend that you decrease the quantity of the laundry. It is possible to keep the full load but the washing results can be unsatisfactory. Recommended load: cotton: 3,5 kg, synthetics and delicates: 1,5 kg.

CONSUMPTION VALUES



The data in this table are approximate. Different variables can affect the data: the quantity and type of laundry, the water and ambient temperature.



At the start of the programme, the display shows the programme duration for the maximum load capacity.

During the washing phase the programme duration is automatically calculated and can be greatly reduced if the laundry load is lower than the maximum load capacity (e.g. Cotton 60°C, maximum load capacity 7 kg, the programme duration exceeds 2 hours; actual load 1 kg, the programme duration will be less than 1 hour).

When the appliance is calculating the real programme duration a dot flashes in the display.

Programmes	Load (kg)	Energy consumption (kWh)	Water consumption (litre)	Approximate programme duration (minutes)	Remaining moisture (%) ¹⁾
Cotton 60°C	7	1,16	58	197	53
Cotton 40°C	7	0,61	56,2	192	53
Synthetics 40°C	3	0,45	46	105	35
Delicates 40°C	2,5	0,55	46	90	35
Wool/Handwash 30°C ²⁾	1	0,35	50	65	30

Standard cotton programmes

Standard 60°C cotton 	7	0,95	47	255	53
Standard 60°C cotton 	3,5	0,65	39	188	53
Standard 40°C cotton 	3,5	0,59	39	187	53

1) At the end of spin phase.

2) Not available for some models.

Off Mode (W)	Left On Mode (W)
0.48	0.48

The information given in the chart above is compliant with the EU Commission regulation 1015/2010 implementing directive 2009/125/EC

OPTIONS

TEMPERATURE

With this option you can change the default temperature.

Indicator  = cold water.

The indicator of the set temperature comes on.

SPIN

With this option you can change the default spin speed.

The indicator of the set speed comes on.

Additional spin options:

No Spin

- Set this option to deactivate all spin phases. Only the drain phase is available.
- The related indicator comes on.
- Set this option for very delicate fabrics.
- The rinses phase uses more water for some washing programmes.

Rinse Hold

- Set this option to prevent the laundry creases.
- The related indicator comes on.
- There is a water in the drum when the programme is completed.

- The drum turns regularly to prevent the laundry creases.
- The lid stays locked. You must drain the water to unlock the lid.



To drain the water refer to 'At the end of the programme'.

QUICK

With this option you can decrease the programme duration.

Use this option for items with light soil or items to refresh.

The related indicator comes on.

PREWASH

With this option you can add a prewash phase to a washing programme.

Use this option for heavy soil. When you set this option the programme duration increases.

The related indicator comes on.

EASY IRON

The appliance carefully washes and spins the laundry to prevent the creases.

The appliance decreases the spin speed, uses more water and adapts the programme duration to the type of laundry.

The related indicator comes on.



RINSE

With this option you can perform only a last rinse of a selected washing programme.

SETTINGS



PERMANENT EXTRA RINSE

With this option you can permanently have an extra rinse when you set a new programme.

- To **activate/deactivate** this option touch the buttons  and  at the same time until the indicator  **comes on/goes off**.

CHILD LOCK

With this option you can prevent that the children play with the control panel.

- To **activate/deactivate** this option, touch the buttons  and  at the same time until the indicator  **comes on/goes off**.

If you set also the Extra Rinse function () the appliance adds two or more rinses. The related indicator comes on.

DRAIN & SPIN

With this option you can perform the spin and drain cycle.

The spin phase is suitable to the washing programme you set.



If you set also the No Spin  option, the appliance only drains.

FINISH IN

With this option you can set the number of hours in which you would like your washing programme to be completed.

You can set from minimum 3 hours to maximum 20 hours.



The display shows the number of hours and the indicator above the button  is on.

EXTRA RINSE

With this option you can add some rinses to a washing programme.

Use this option for persons allergic to detergents and in areas where the water is soft.

The related indicator comes on.¹⁾

Activate this option after you touch the button : the buttons are locked (except for the button ).



This option stays active even when you switch off the appliance.

ACOUSTIC SIGNALS

The acoustic signals operate when:

- The programme is completed.
- The appliance has a malfunction.

To **deactivate/activate** the acoustic signals,

touch the buttons **P** and  at the same time for 4 seconds.

¹⁾ See in "Settings" how to activate this option.



If you deactivate the acoustic signals, they continue operate when the appliance has a malfunction.

BEFORE FIRST USE

1. Put a small quantity of detergent in the compartment for washing phase.
2. Set and start a programme for cotton at the highest temperature without laundry.

This removes all possible dirt from the drum and the tub.

DAILY USE



WARNING! Refer to Safety chapters.

ACTIVATING THE APPLIANCE

Press and hold for a couple of seconds the On/Off button to activate or deactivate the appliance.

A tune sounds when the appliance is activated. The display shows the word On.

LOADING THE LAUNDRY

1. Open the appliance lid.
2. Push the button **A**.
The drum opens automatically.
3. Put the laundry in the drum, one item at a time.
4. Shake the items before you put them in the appliance.

Make sure not to put too much laundry in the drum.

5. Close the drum and the lid.

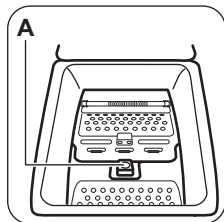

CAUTION! Before you close the lid of your appliance, make sure that you close the drum correctly.

USING DETERGENT AND ADDITIVES

1. Measure out the detergent and the fabric conditioner.
2. Put the detergent and the fabric conditioner into the compartments.

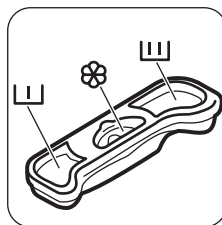

DETERGENT COMPARTMENTS

	Detergent compartment for pre-wash phase.
	Detergent compartment for washing phase.
	Compartment for liquid additives (fabric conditioner, starch).
	CAUTION! Do not exceed the M level.



SETTING A PROGRAMME

1. Touch the programme button **P** and set the programme:
 - The indicator of the button flashes.
 - The display shows the programme duration.
2. If necessary, change the temperature and the spin speed or add available options. When you activate an option, the indicator of the set option comes on.



If you set something incorrect, the display shows the message **Err**.

Touch the button .

- The indicator of the button  stops to flash and stays on.
- The programme starts, the lid locks, the indicator  is on.
- The drain pump can operate for a short time at the beginning of the washing cycle.





After approximately 15 minutes from the start of the programme:

- The appliance adjusts automatically the programme duration agree with the laundry load.
- The display shows the new value.



STARTING A PROGRAMME WITH THE FINISH IN OPTION

1. Touch the button  again and again to choose the number of hours in which you want the washing cycle to be finished.



The display shows the number of hours you set (e.g. 3h) and the indicator above the button  is on to show that this option is active.

2. Touch the button :
 - The door is locked.
 - The appliance starts the countdown.
 - When the countdown is completed, the programme starts automatically.



You can cancel or change the set of the Finish In option before you touch the button . After touching the button  you can only cancel the Finish In option.

To cancel the the Finish In option:

- a. Touch the button  to set the appliance to pause. The indicator of button  flashes.
- b. Touch the button  until the indicator above this button goes off.

Touch the button  again to start the programme immediately.



When using liquid detergents in combination with the Finish In option, add the liquid detergents with a dosing ball (supplied by the detergent's manufacturer).

INTERRUPTING A PROGRAMME AND CHANGING THE OPTIONS

You can change only some options before they operate.

1. Touch .

The indicator of this button flashes.

2. Change the options. If you change any option the Finish In option (if set) will be disabled.

3. Touch  again.

The programme continues.



CANCELLING A PROGRAMME

1. Press the button On/Off for some seconds to cancel the programme and to deactivate the appliance.
2. Press the same button again to activate the appliance. Now, you can set a new washing programme.



Before starting the new programme the appliance could drain the water. In this case, make sure that the detergent is still in the detergent compartment, if not fill the detergent again.





OPENING THE LID

While a programme (or the  operates, the appliance lid is locked. The indicator  is on.







CAUTION! If the temperature and level of the water in the drum are too high, you cannot open the lid.

To open the lid during the first minutes of the cycle (or when the operates) :



1. Touch the button  to pause the appliance.
2. Wait a couple of minutes until the indicator  goes off.
3. You can open the lid.
4. Close the lid and touch the button  again. The programme (or the  continues.

AT THE END OF THE PROGRAMME





- The appliance stops automatically.
- The acoustic signal operates (if it is activated).
- In the display  comes on.
- The indicator of the button  goes off.
- The lid lock indicator  blinks (when the lid is unlocking) and then goes off.
- You can open the lid.



- Remove the laundry from the appliance. Make sure that the drum is empty.
- Press the button  for some seconds to deactivate the appliance.
- Close the water tap.
- Keep the lid ajar, to prevent the mildew and odours.

The washing programme is completed, but there is water in the drum:

- The drum turns regularly to prevent the creases in the laundry.
- The indicator  flashes to remind you to drain the water.
- The lid lock indicator  is on. The indicator of button  flashes. The lid stays locked.
- You must drain the water to open the lid.

Draining the water:

1. To drain the water.
 - Touch the button . The appliance drains the water and spins with the maximum spin speed for selected washing programme.
 - Alternatively, touch the button  to change the spin speed and then touch the button . The appliance drains the water and spins. If you set , the appliance only drains.



2. When the programme is completed and after a couple of minutes the lid lock indicator  goes off, you can open the lid.
3. Press the button  for some seconds to deactivate the appliance.



The appliance drains and spins automatically after approximately 18 hours (except for Wool programme).

AUTO-OFF OPTION

The AUTO-OFF stand-by option automatically deactivates the appliance to decrease the energy consumption. All the indicators and the display go off when :

- You do not use the appliance for 5 minutes before you touch . Press the button  to activate the appliance again.
- After 5 minutes from the end of the washing programme. Press the button  to activate the appliance again. The display shows the end of the last set programme. Touch the button **P** if you want to set a new cycle.

HINTS AND TIPS

THE LAUNDRY LOAD

- Divide the laundry in: white, coloured, synthetics, delicates and wool.
- Obey the washing instructions that are on the laundry care labels.
- Do not wash white and coloured items together.
- Some coloured items can discolour with the first wash. We recommend that you wash them separately for the first times.
- Button up pillowcases, close zippers, hooks and poppers. Tie up belts.
- Empty the pockets and unfold the items.
- Turn multilayered fabrics, wool and items with painted illustrations inside out.
- Remove hard stains.
- Wash heavy soil stains with a special detergent.
- Be careful with the curtains. Remove the hooks and put the curtains in a washing bag or pillowcase.
- Do not wash laundry without hems or with cuts. Use a washing bag to wash small and/or

- delicate items (e.g. underwired bras, belts, tights, etc.).
- A very small load can cause balance problems with the spin phase. If this occurs, adjust manually the items in the tub and start the spin phase again.

STUBBORN STAINS

For some stains, water and detergent is not sufficient.

We recommend that you pre-treat these stains before you put the items in the appliance. Special stain removers are available. Use the special stain remover that is applicable to the type of stain and fabric.

DETERGENTS AND ADDITIVES

- Only use detergents and additives specially made for washing machines:
 - powder detergents for all types of fabric,
 - powder detergents for delicate fabrics (40 °C max) and woollens,

- liquid detergents, preferably for low temperature wash programmes (60 °C max) for all types of fabric, or special for woollens only.
- Do not mix different types of detergents.
- To help the environment, do not use more than the correct quantity of detergent.
- Obey the instructions that you find on the on packaging of these products.
- Use the correct products for the type and colour of the fabric, the programme temperature and the level of soil.
- If your appliance does not have the detergent dispenser with the flap device, add the liquid detergents with a dosing ball (supplied by the detergent's manufacturer).
- Always start a washing programme with the maximum load of laundry allowed.
- If necessary, use a stain remover when you set a programme with a low temperature.
- To use the correct quantity of detergent, check the water hardness of your domestic system. Refer to "Water hardness".

WATER HARDNESS

If the water hardness in your area is high or moderate, we recommend that you use a water softener for washing machines. In areas where the water hardness is soft it is not necessary to use a water softener.

To know the water hardness in your area, contact your local water authority.

Use the correct quantity of the water softener. Obey the instructions that you find on the packaging of the product.

ECOLOGICAL HINTS

- Set a programme without the prewash phase to wash laundry with normal soil.

CARE AND CLEANING



WARNING! Refer to Safety chapters.

EXTERNAL CLEANING

Clean the appliance with soap and warm water only. Fully dry all the surfaces.



CAUTION! Do not use alcohol, solvents or chemical products.

DESCALING

If the water hardness in your area is high or moderate, we recommend that you use a water descaling product for washing machines.

Regularly examine the drum to prevent limescale and rust particles.

To remove rust particles use only special products for washing machines. Do this separately from the laundry wash.



Always obey the instructions that you find on the packaging of the product.

MAINTENANCE WASH

With the low temperature programmes it is possible that some detergent stays in the drum. Perform a maintenance wash regularly. To do this:

- Remove all laundry from the drum.

LID SEAL

Regularly examine the seal. Clean it when needed, using ammonia cream cleanser agent without scratching the seal surface,



Always obey the instructions that you find on the packaging of the product.

CLEANING THE DETERGENT DISPENSER

1.

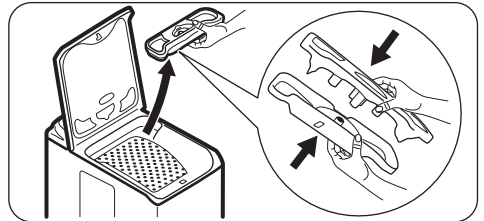

2.

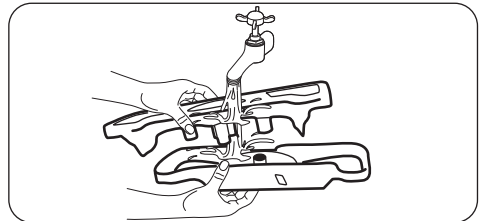

3.

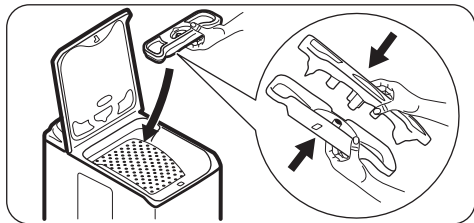

CLEANING THE DRAIN FILTER



Do not clean the drain filter if the water in the appliance is hot.

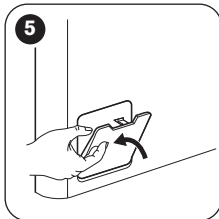
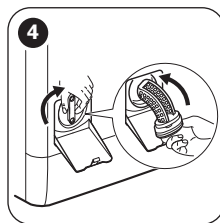
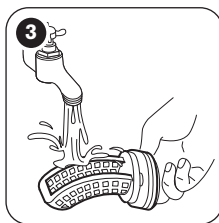
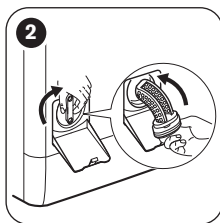
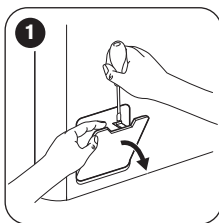

CLEANING THE INLET HOSE AND THE VALVE FILTER

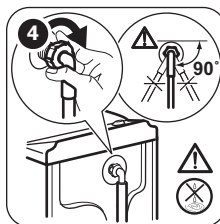
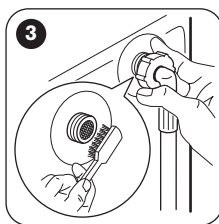
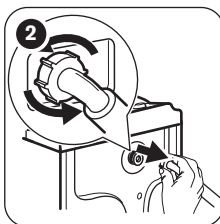
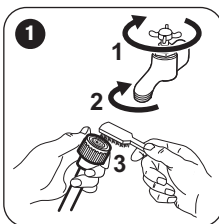

FROST PRECAUTIONS

If the appliance is installed in an area where the temperature can be less than 0 °C, remove the remaining water from the inlet hose and the drain pump.



Do this procedure also when you want to do the emergency drain.

1. Disconnect the mains plug from the mains socket.
2. Close the water tap and disconnect the water inlet hose.

3. Disconnect the drain hose from a sink or spigot.
4. Put the ends of the drain and inlet hose in a container. Let the water flow out of the hoses.
5. Connect the mains plug to the mains socket and activate the appliance again.
6. Set any washing cycle together with the option "Drain and Spin" and let it operate until the end of the cycle.
7. Press the button  to deactivate the appliance.

8. Disconnect the appliance from the mains socket.



WARNING!

Make sure that the temperature is more than 0 °C before you use the appliance again. The manufacturer is not responsible for damages caused by low temperatures.

TROUBLESHOOTING



WARNING! Refer to Safety chapters.

INTRODUCTION

The appliance does not start or it stops during operation.

First try to find a solution to the problem (refer to the table). If the problem persists, contact the Authorised Service Centre.

With some problems, the acoustic signals operate and the display shows an alarm code:

- *E10* - The appliance does not fill with water properly.

- *E20* - The appliance does not drain the water.
- *E40* - The appliance lid or drum doors are open or not closed correctly. Please check both!
- *E40* - The mains supply is unstable. Wait until the mains supply is stable.
- *E91* - No communication between electronic elements of the appliance. Switch off and switch on again.



WARNING! Deactivate the appliance before you do the checks.

POSSIBLE FAILURES

Problem	Possible solution
The programme does not start.	<ul style="list-style-type: none"> ▪ Make sure that the mains plug is connected to the mains socket. ▪ Make sure that the appliance lid and drum doors are closed properly. ▪ Make sure that there is not a damaged fuse in the fuse box. ▪ Make sure that the Start/Pause has been pressed. ▪ If the delay start is set, cancel the setting or wait for the end of countdown. ▪ Deactivate the Child Lock function if it is on.
The appliance does not fill with water properly.	<ul style="list-style-type: none"> ▪ Make sure that the water tap is open. ▪ Make sure that the pressure of the water supply is not too low. For this information, contact your local water authority. ▪ Make sure that the water tap is not clogged. ▪ Make sure that the filters of the inlet hoses and the filters of the valves are not clogged. Refer to "Care and cleaning". ▪ Make sure that the inlet hose has no kinks or bends. ▪ Make sure that the connection of the water inlet hose is correct.

Problem	Possible solution
The appliance does not fill with water and drain immediately.	<ul style="list-style-type: none"> ▪ Make sure that the drain hose is in the correct position. The hose may be too low.
The appliance does not drain the water.	<ul style="list-style-type: none"> ▪ Make sure that the sink spigot is not clogged. ▪ Make sure that the drain hose has no kinks or bends. ▪ Make sure that the connection of the drain hose is correct. ▪ Set the drain option if you set a programme without drain phase. ▪ Set the drain option if you set an option which ends with water in the drum. ▪ Make sure that the drain filter is not clogged. Clean the filter, if necessary. Refer to 'Care and cleaning'. ▪ If problem remains please contact the Authorised Service Centre.
The spin phase does not operate or the washing cycle lasts longer than usually.	<ul style="list-style-type: none"> ▪ Adjust manually the items in the tub and start the spin phase again. This problem may be caused by balance problems. ▪ Set the spin option. ▪ Set the drain option if you set an option which ends with water in the drum. ▪ Make sure that the drain filter is not clogged. Clean the filter, if necessary. Refer to 'Care and cleaning'.
There is water on the floor.	<ul style="list-style-type: none"> ▪ Make sure that the couplings of the water hoses are tight and there is not water leakages. ▪ Make sure that the water inlet hose and the drain hose have no damages. ▪ Make sure you use the correct detergent and the correct quantity of it.
You cannot open the appliance lid.	<ul style="list-style-type: none"> ▪ Make sure that the washing programme is finished. ▪ Set the drain or the spin option if there is water in the drum.
The appliance makes an unusual noise.	<ul style="list-style-type: none"> ▪ Make sure the levelling of the appliance is correct. Refer to 'Installation instruction'. ▪ Make sure that the packaging and/or the transit bolts are removed. Refer to 'Installation instruction'. ▪ Add more laundry in the drum. The load may be too small.
The appliance fills with water and drain immediately.	<ul style="list-style-type: none"> ▪ Make sure that the drain hose is in the correct position. The end of the hose may be too low. Refer to 'Installation instruction'.
The cycle is shorter than the time displayed.	<ul style="list-style-type: none"> ▪ The appliance calculates a new time according to the laundry load. See the 'Consumption Values' chapter.
The cycle is longer than the time displayed.	<ul style="list-style-type: none"> ▪ An unbalanced laundry load increases the duration time. This is a normal behaviour of the appliance.
The washing results are not satisfactory.	<ul style="list-style-type: none"> ▪ Increase the detergent quantity or use a different detergent. ▪ Use special products to remove the stubborn stains before you wash the laundry. ▪ Make sure that you set the correct temperature. ▪ Decrease the laundry load.
You cannot set an option.	<ul style="list-style-type: none"> ▪ Make sure that you press only the wanted touch button(s).

After the check, activate the appliance. The programme continues from the point of interruption. If the problem occurs again, contact the Authorised Service Centre.

If the display shows other alarm codes. Deactivate and activate the appliance. If the problem continues, contact the Authorised Service Centre.

SERVICE

We recommend the use of original spare parts. When contacting the Authorised Service Centre, make sure that these data are available. You can find the information on the rating plate: model, PNC and Serial Number. (Mod., Prod. No., Ser. No.)

TECHNICAL DATA

Dimension	Width/ Height/ Depth/ Total depth	400 mm/ 890 mm/ 600 mm/ 600 mm
Electrical connection	Voltage Overall power Fuse Frequency	220-230 V 2200 W 10 A 50 Hz
Level of protection against ingress of solid particles and moisture ensured by the protective cover, except where the low voltage equipment has no protection against moisture		IPX4
Water supply pressure	Minimum Maximum	0,5 bar (0,05 MPa) 8 bar (0,8 MPa)
Water supply ¹⁾		Cold water
Maximum Load	Cotton	7 kg
Energy Efficiency Class		A+++
Spin Speed	Maximum	1200 rpm

1) Connect the water inlet hose to a water tap with a 3/4" thread.

ENVIRONMENTAL CONCERNS

Recycle the materials with the symbol . Put the packaging in applicable containers to recycle it. Help protect the environment and human health and to recycle waste of electrical and electronic appliances. Do not dispose appliances marked with

the symbol  with the household waste. Return the product to your local recycling facility or contact your municipal office.

WWW.ZANUSSI.COM/SHOP



CE

192947250-A-462016